

# Installation and Configuration Quick Guide

## R3000 Quad

Industrial Cellular VPN Router with 4 Ethernet Ports  
(4 Eth + 1 RS-232/1 RS-485 + 1 USB Host)

### Package Contents

Before installing your R3000 Quad Router, please verify the kit contents as following.

- 1 x Robustel GoRugged R3000 Quad Industrial Dual SIM Cellular VPN Router with 4 Ethernet Ports
- 1 x 3-pin pluggable terminal block with lock for power supply
- 1 x 7-pin pluggable terminal block with lock for serial and console port
- 1 x *Quick Start Guide* with download link of other documents or tools

**\*If any of the above items is missing or damaged, please contact your Robustel sales representative.**

### Optional Accessories (sold separately)

- 3G/4G SMA cellular antenna (stubby/magnet optional)
- Wall mounting kit
- 35 mm DIN rail mounting kit
- Ethernet cable
- AC/DC power adapter (12V DC, 1.5 A; EU/US/UK/AU plug optional)

### Environmental Requirements

- Power input: 9~60V DC
- Power consumption: 100 mA@12 V in idle state, 400 mA (peak) @12 V in communication state
- Operating temperature: -40~75 °C
- Relative humidity: 5~95% RH

# Hardware Introduction

## 1. Overview

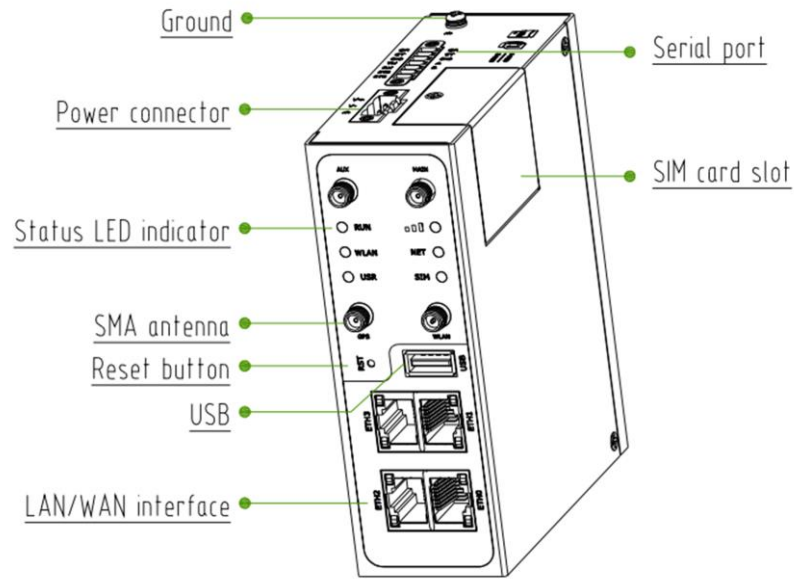

## 3. Pinouts

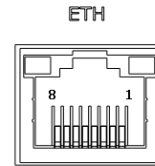

PIN	Function
1	TX+
2	TX-
3	RX+
6	RX-

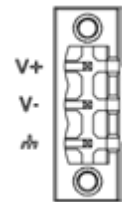

PIN	Polarity
8	Positive
9	Negative
10	GND

## 2. Dimensions

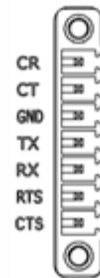
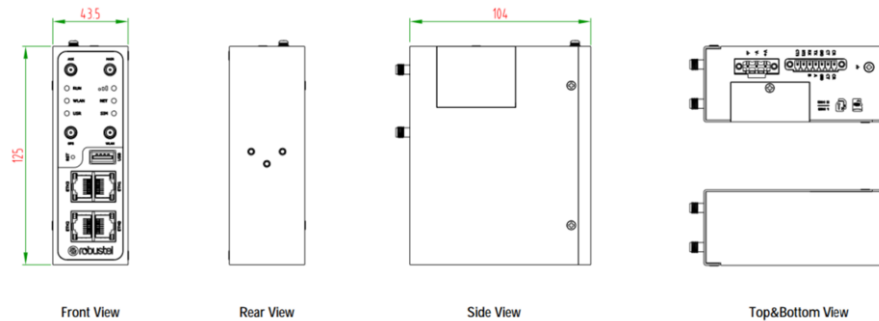

PIN	Debug	RS-232	RS-485	Direction
1	CR	--	--	Router ← Device
2	CT	--	--	Router → Device
3	GND	GND	GND	--
4	--	TXD	Data+(A)	Router → Device
5	--	RXD	Data+(B)	Router ← Device
6	--	RTS	--	Router → Device
7	--	CTS	--	Router ← Device

## 4. LED Indicators

Name	Color	Status	Description
RUN	Green	On, fast blinking (250 mSec blink time)	Router is powered on (System is initializing)
		On, blinking (500 mSec blink time)	Router starts operating
		Off	Router is powered off
PPP	Green	On, solid	Link connection is working
		Off	Link connection is not working
USR- OpenVPN	Green	On, solid	OpenVPN connection is established
		Off	OpenVPN connection is not established
USR-IPsec	Green	On, solid	IPsec connection is established
		Off	IPsec connection is not established
USR-WiFi	Green	On, solid	WiFi is enabled and working properly
		Off	WiFi is disabled or not working properly
	Green	On, solid	High Signal strength (21-31) is available
	Yellow	On, solid	Medium Signal strength (11-20) is available
	Red	On, solid	Low Signal strength (1-10) is available
	/	Off	No signal

Name	Color	Status	Description
NET	Green	On, solid	Connection to 4G network is established
	Yellow	On, solid	Connection to 3G network is established
	Red	On, solid	Connection to 2G network is established
	/	Off	Connection to network is not established or establishing
SIM	Green	On, blinking	Backup card is being used
		Off	Main card is being used

## 5. USB Interface

Function	Operation
Firmware upgrade	USB interface is used for batch firmware upgrading, but cannot be used for sending or receiving data from slave devices which connected to it. You can insert a USB storage device into the router's USB interface, such as a U disk or a hard disk. If there have a supported configuration file or a router firmware in this USB storage device, the router will automatically update the configuration file or the firmware.

## 6. Reset Button

Function	Operation
Reboot	Press and hold the RST button for 5 seconds under the operating status.
Restore to factory default settings	Wait for 5 seconds after powering up the router, press and hold the RST button until all six LEDs start blinking one by one, and release the button to return the router to factory defaults.

## 7. Ethernet Port

R3000 Quad Router has four Ethernet port with two LED indicators. The yellow one is link indicator and the green one is speed indicator. For details about status, see the table below.

Indicator	State	Description
Link indicator	On, solid	Connection is established
	On, blinking	Data is being transferred
	Off	Connection is not established
Speed indicator	On, solid	100 Mbps mode
	Off	10 Mbps mode

# Hardware Installation

## 1. Insert or Remove SIM Card/Micro SD Card

### ● Insert SIM card/Micro SD card

1. Make sure router is powered off.
2. To remove cover, loosen the screws associated with the cover by using a screwdriver and then find the SIM card slot/Micro SD card slot.
3. To insert SIM card/Micro SD card, press the card with finger until you hear a click and then tighten the screws associated with the cover by using a screwdriver.
4. To put back the cover and tighten the screws associated with the cover by using a

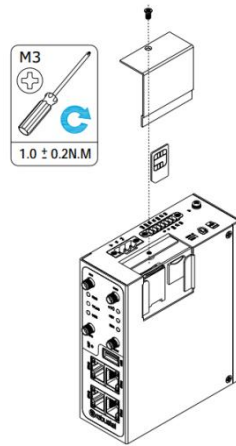

### ● Remove SIM card/Micro SD card

1. Make sure router is powered off.
2. To remove slot cover, loosen the screws associated with the cover by using a screwdriver and then find the SIM card slot/Micro SD card slot.
3. To remove SIM card/Micro SD card, press the card with finger until it pops out and then take out the card.
4. To put back the cover and tighten the screws associated with the cover by using a screwdriver.

### Note:

1. Recommended torque for inserting is 1.0 N.m, and the maximum allowed is 1.2 N.m.
2. Use the specific card when the device is working in extreme temperature (temperature exceeding 40 °C), because the regular card for long-time working in harsh environment will be disconnected frequently.

3. Do not forget to twist the cover tightly to avoid being stolen.
4. Do not touch the metal of the card surface in case information in the card will be lost or destroyed.
5. Do not bend or scratch the card.
6. Keep the card away from electricity and magnetism.
7. Make sure router is powered off before inserting or removing the card.

## 2. Attach External Antenna (SMA Type)

Attach the SMA external antenna to the router's connector and twist tightly. Make sure the antenna is within the correct frequency range provided by the operator and with 50 Ohm impedance.

**Note:** Recommended torque for mounting is 0.35 N.m.

## 3. Connect the Router to a Computer

Connect an Ethernet cable to any port marked ETH0~ETH3 at the bottom of the router, and connect the other end of the cable to your computer.

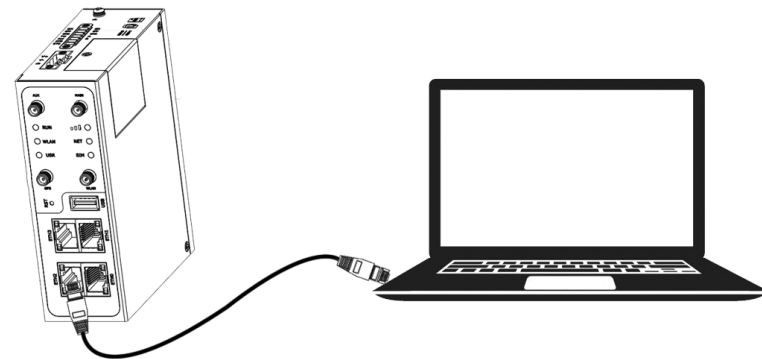

## 4. Mount the Router

The router can be placed on a desktop or mounted to a wall or a 35 mm DIN rail.

### Two methods for mounting the router

- **Wall mounting** (measured in mm)

Use 3 pcs of M3\*4 flat head Phillips screws to fix the wall mounting kit to the router, and then use 2 pcs of M3 drywall screws to mount the router associated with the wall mounting kit on the wall.

**Note:** Recommended torque for mounting is 1.0 N.m, and the maximum allowed is 1.2 N.m.

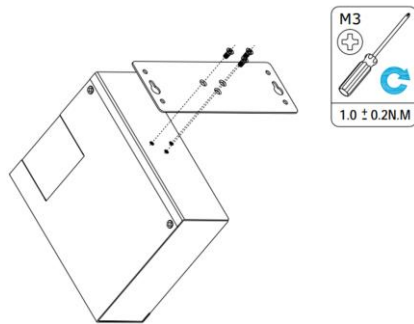
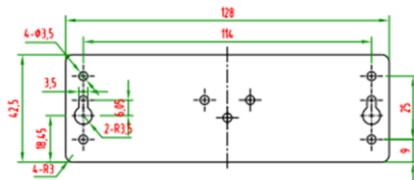

- **DIN rail mounting** (measured in mm)

Use 3 pcs of M3\*6 flat head Phillips screws to fix the DIN rail to the router, and then hang the DIN rail on the mounting bracket. It is necessary to choose a standard bracket.

**Note:** Recommended torque for mounting is 1.0 N.m, and the maximum allowed is 1.2 N.m.

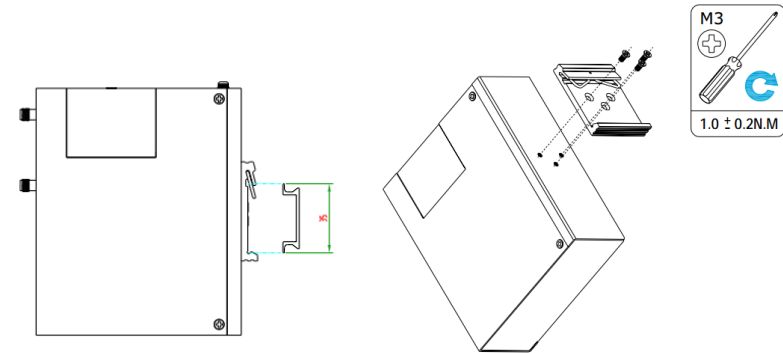

## 5. Power Supply

### CONNECTING THE POWER CABLE

COLOR	POLARITY
RED	+
YELLOW	-

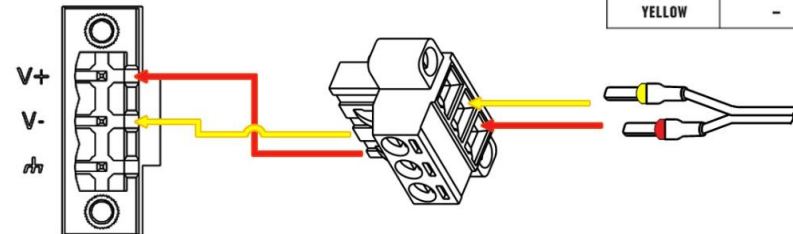

R3000 Quad router supports reverse polarity protection, but always refers to the figure above to connect the power adapter correctly. There are two cables associated with the power adapter. Following to the color of the head, connect the cable marked red to the positive pole through a terminal block, and connect the yellow one to the negative in the same way.

**Note:** The range of power voltage is 9 to 60V DC.

# PC Configuration

There are two methods to get IP address for the PC, one is to obtain an IP address automatically from “Local Area Connection”, and another is to configure a static IP address manually within the same subnet of the router. Please refer to the steps below.

Here take **Windows 7** as example, and the configuration for windows system is similar.

1. Click **Start > Control panel**, double-click **Network and Sharing Center**, and then double-click **Local Area Connection**.

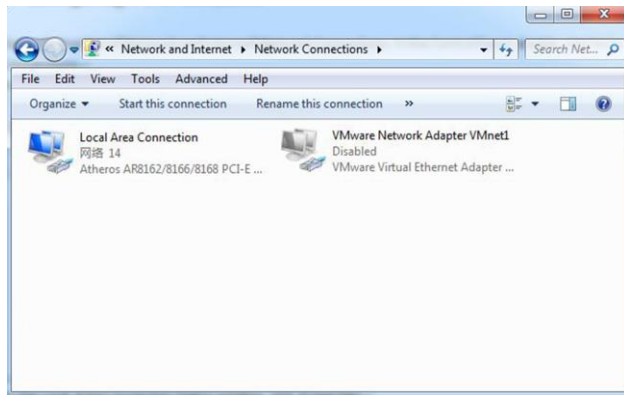

2. Click **Properties** in the window of **Local Area Connection Status**.

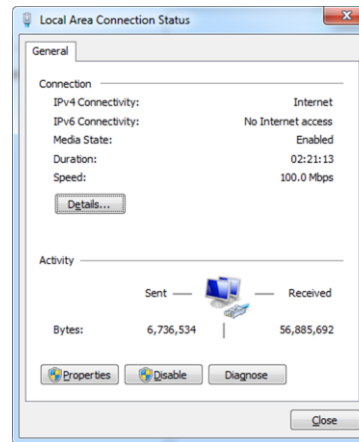

3. Choose **Internet Protocol Version 4 (TCP/IPv4)** and click **Properties**.

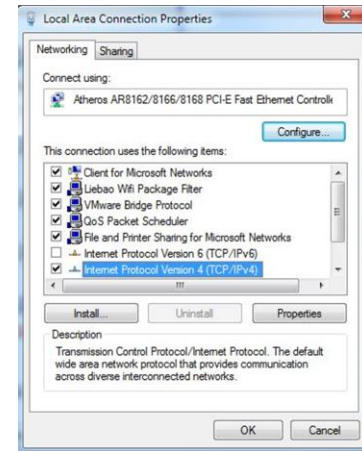

4. Two ways for configuring the IP address of PC.  
**Obtain an IP address automatically:**



## Use the following IP address

(Configured a static IP address manually within the same subnet of the router)

5. Click **OK** to finish the configuration.

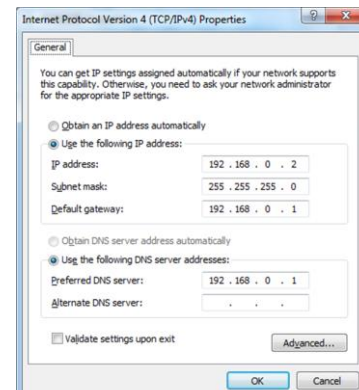

# Router Configuration

## 1. Log in the Router

To log in to the management page and view the configuration status of your router, please follow the steps below.

1. On the PC, open a web browser such as Internet Explorer, Google and Firefox etc.
2. From your web browser, type the IP address of the router into the address bar and press enter. The default IP address of the router is [192.168.0.1](http://192.168.0.1), though the actual address may vary.

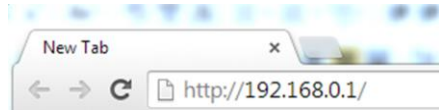

3. In the login page, enter the username and password, choose language and then click **LOGIN**. The default username and password are “admin”.



**Note:** If enter the wrong username or password over six times, the login web will be locked for 5 minutes.

4. After logging in, the home page of the R3000 Quad Router’s web interface is displayed, for example.



**Note:** To configure parameters should follow this order “modify parameter 1 > Submit > modify parameter 2 > Submit > Save & Apply”.

## 2. Configure the Cellular Connection

Click **Interface > Link Manager > Link Manager > General Settings**, choose “WWAN1” as the primary link and “WWAN2” as the backup link, and set “Cold Backup” as the backup mode, then click “Submit”.

**Note:** Link Settings allows you to configure the parameters of link connection, including WWAN1/WWAN2, WAN and WLAN. It is recommended to enable Ping detection to keep the router always online. The Ping detection increases the reliability and also costs the data traffic.





^ Link Settings			
Index	Type	Description	Connection Type
1	WWAN1		DHCP
2	WWAN2		DHCP
3	WAN		DHCP
4	WLAN		DHCP

Click  on the right-most of WWAN1 to enter the configuration window.

**Link Manager**

**^ General Settings**

Index:

Type:

Description:

The window is displayed as below when enabling the “Automatic APN Selection” option.

**^ WWAN Settings**

Automatic APN Selection:  ON  OFF

Dialup Number:

Authentication Type:

Switch SIM By Data Allowance:  ON  OFF

Data Allowance:

Billing Day:

The window is displayed as below when enabling the “Ping Detection” option.

**^ Ping Detection Settings**

Enable:  ON  OFF

Primary Server:

Secondary Server:

Interval:

Retry Interval:

Timeout:

Max Ping Tries:

**^ Advanced Settings**

NAT Enable:  ON  OFF

Upload Bandwidth:

Download Bandwidth:

Overridden Primary DNS:

Overridden Secondary DNS:

Debug Enable:  ON  OFF

Verbose Debug Enable:  ON  OFF

When finished, click **Submit > Save & Apply** for the configuration to take effect.

### 3. Check the Cellular Connection Status

Click **Interface > Cellular > Status** to view the status of the cellular connection, and click the row of status, the details status information will be displayed under the row.

Cellular	Status	AT Debug		
^ Status				
Index	Modem Status	Modem Model	IMSI	Registration
1	Ready	MC7430	460015866618891	Registered to home network

**^ Status**

Index	Modem Status	Modem Model	IMSI	Registration
1	Ready	MC7430	460015866618891	Registered to home network
Index 1				
Modem Status Ready				
Modem Model MC7430				
Current SIM SIM1				
Phone Number				
IMSI 460015866618891				
ICCID NOT				
Registration Registered to home network				
Network Provider CHN-UNICOM				
Network Type LTE				
Signal Strength 31 (-51dBm)				
Bit Error Rate 99				
PLMN ID 46001				
Local Area Code FFFE				
Cell ID 6074702				
IMEI 359074060118488				
Firmware Version SW19X30C_02.14.03.00 r6134 CARMD-EV-FRMWR2 2016/0...				

#### 4. Configure the IP of Router

There are four Ethernet ports on R3000 Quad Router, including ETH0~ETH3. The ETH0 on the router can be configured as either a WAN or a LAN port, while ETH1~ETH3 can only be configured as LAN ports. The ETH0~ETH3 can freely choose from lan0~lan3, but at least one LAN port must be assigned as lan0. The default settings of ETH0~ETH3 are lan0 and their default IP are 192.168.0.1/255.255.255.0.

- **Configure Lan0**

Click **Interface > LAN > LAN**, click lan0's edit button to configure its configuration, and modify its IPv4 address and Netmask.

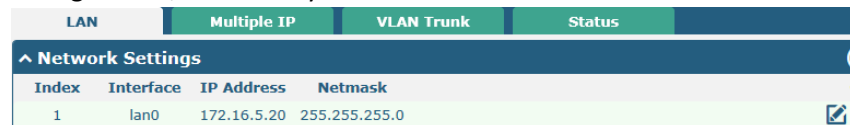

Index	Interface	IP Address	Netmask
1	lan0	172.16.5.20	255.255.255.0

Click lan0's edit button and configure its parameters in the pop up window.

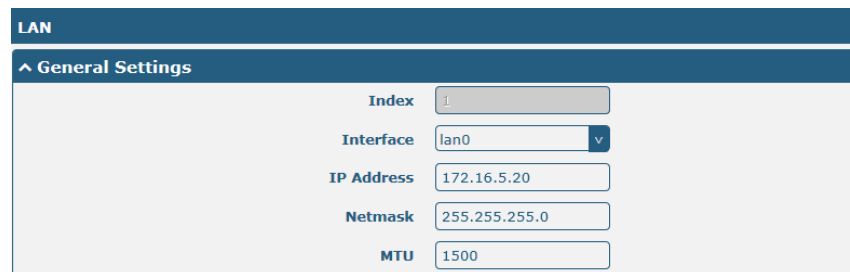

**LAN**

**General Settings**

Index: 1

Interface: lan0

IP Address: 172.16.5.20

Netmask: 255.255.255.0

MTU: 1500

When finished, click **Submit > Save & Apply** for the configuration to take effect.

- **Configure Lan1**

Click **Interface > Ethernet > Ports**, click eth1's edit button, choose "lan1" as the assigned port, and click "Submit".

**Note:** By default, there is a LAN port (lan0) in the list. To begin adding a new LAN port (lan1), please configure one of eth0~eth3 as lan1 first in **Ethernet > Ports > Port Settings**. Otherwise, the operation will be prompted as "List is full".

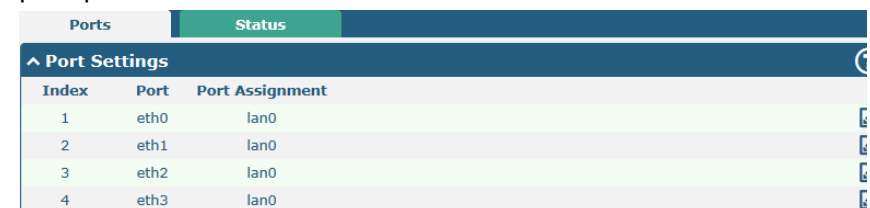

Index	Port	Port Assignment
1	eth0	lan0
2	eth1	lan0
3	eth2	lan0
4	eth3	lan0

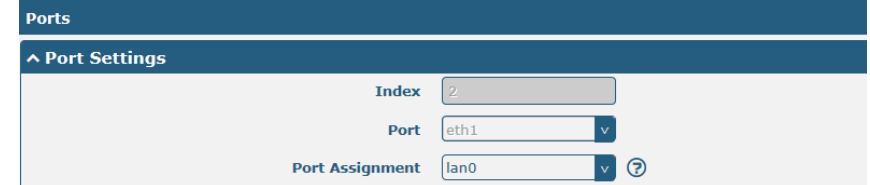

Index: 2

Port: eth1

Port Assignment: lan0

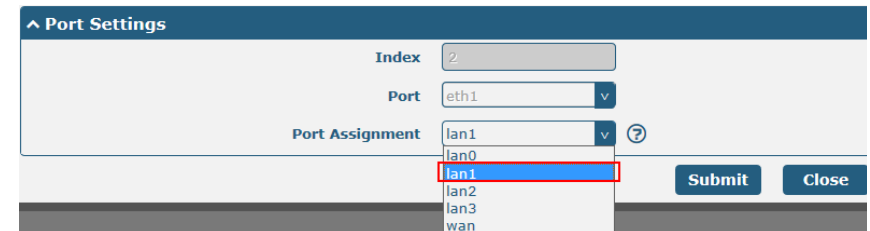

Index: 2

Port: eth1

Port Assignment: lan1

lan0

lan1

lan2

lan3

wan

Submit Close

Click **Interface > LAN** in the homepage, and click the add button.

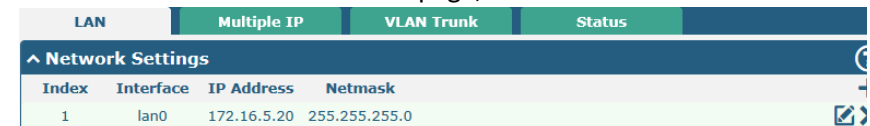

Index	Interface	IP Address	Netmask
1	lan0	172.16.5.20	255.255.255.0

Choose lan1 as the interface, and configure its IPv4 address and Netmask.

LAN

General Settings

Index: 2

Interface: lan1

IP Address: 192.168.0.1

Netmask: 255.255.255.0

MTU: 1500

When finished, click **Submit > Save & Apply** for the configuration to take effect.

- **Configure Multiple IP**

Click **Interface > LAN > Multiple IP**, and click the edit button of lan0.

LAN Multiple IP VLAN Trunk Status

Multiple IP Settings

Index	Interface	IP Address	Netmask
1	lan0	172.16.5.20	255.255.0.0

**Note:** You may click to edit the multiple IP of the LAN port, or click to delete the multiple IP of the LAN port. Now, click to add a multiple IP to the LAN port.

Multiple IP

IP Settings

Index: 1

Interface: lan0

IP Address: 172.16.5.20

Netmask: 255.255.0.0

When finished, click **Submit > Save & Apply** for the configuration to take effect.

- **Configure WAN**

Click **Interface > Ethernet > Ports**, click the edit button of eth0, choose “wan” as the port assignment, and click “Submit”;

Ports Status

Port Settings

Index	Port	Port Assignment
1	eth0	lan0
2	eth1	lan1
3	eth2	lan0
4	eth3	lan0

Ports

Port Settings

Index: 1

Port: eth0

Port Assignment: wan

Submit Close

Click **Interface > Link Manager > General Settings**, choose “WAN” as the primary link, and choose “None” as the backup link.

Link Manager Status

General Settings

Primary Link: WAN

Backup Link: None

Emergency Reboot: OFF

Click the edit button of WAN to enter its configuration window.

Link Settings

Index	Type	Description	Connection Type
1	WWAN1		DHCP
2	WWAN2		DHCP
3	WAN		DHCP
4	WLAN		DHCP

Configure WAN's related parameters as below.

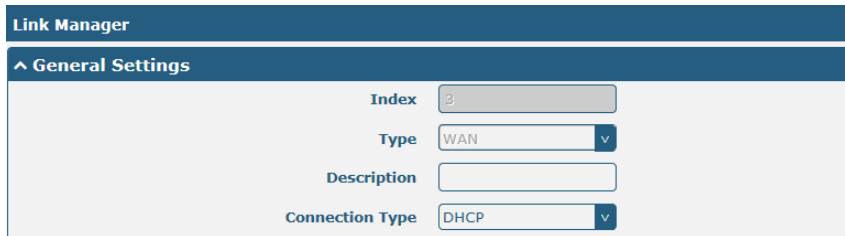

The screenshot shows the 'Link Manager' interface with the 'General Settings' tab selected. The settings are as follows:

Parameter	Value
Index	3
Type	WAN
Description	
Connection Type	DHCP

The window is displayed as below when enabling the “Ping Detection” option.

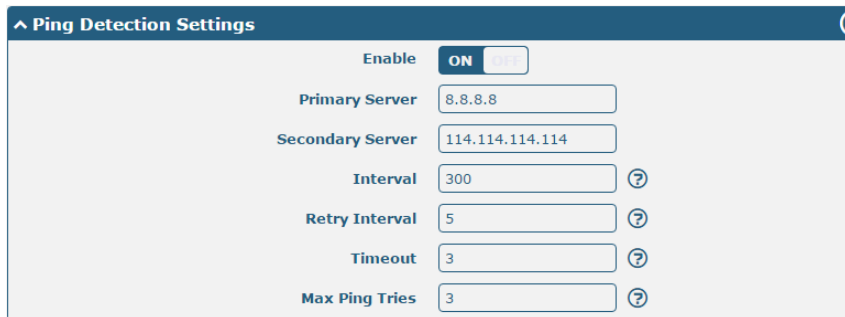

The screenshot shows the 'Ping Detection Settings' window with the 'Enable' option checked. The settings are as follows:

Parameter	Value
Enable	ON
Primary Server	8.8.8.8
Secondary Server	114.114.114.114
Interval	300
Retry Interval	5
Timeout	3
Max Ping Tries	3

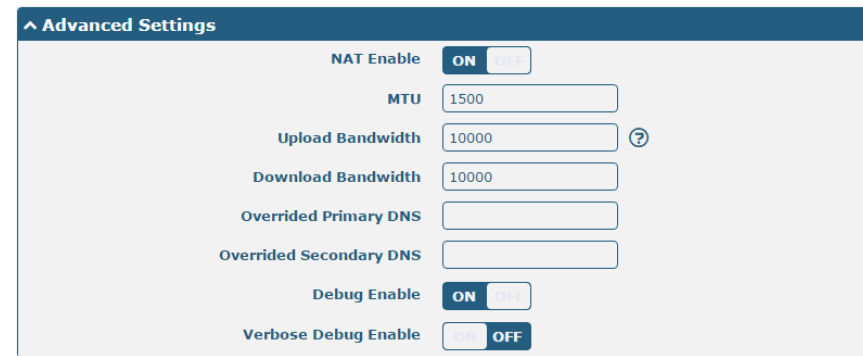

The screenshot shows the 'Advanced Settings' window with the following configurations:

Parameter	Value
NAT Enable	ON
MTU	1500
Upload Bandwidth	10000
Download Bandwidth	10000
Overridden Primary DNS	
Overridden Secondary DNS	
Debug Enable	ON
Verbose Debug Enable	OFF

When finished, click **Submit > Save & Apply** for the configuration to take effect.



**Guangzhou Robustel LTD**

Add: 3rd Floor, Building F, Kehui Park, No.95 Dagan Road, Guangzhou, China 510660

Tel: 086-20-29019902

Email: [info@robustel.com](mailto:info@robustel.com)

Web: [www.robustel.com](http://www.robustel.com)