



ROBUSTEL USE CASE CATALOGUE



Scan to Visit Robustel Website for
More Product Information

marketing@robustel.com
www.robustel.com

NOTE: Specifications are subject to change without notice.
The final interpretation right of the content belongs to Robustel.

Version: August 2024

Contents

Company Overview

Company Introduction	01	Typical Applications	03
----------------------	----	----------------------	----

Solution

Energy & Utilities 05

Electricity Distribution Network Intelligent FTU Networking Solution	07
Urban Water Supply Pipeline Monitoring Solution	09
Wind Turbine Preventive Maintenance Solution	11
Smart Grid Solar Power Station Monitoring Solution	13
EV Charging Pile Networking Solution	15

Smart Cities 17

Urban Road Traffic Monitoring Solution	19
Urban CCTV Solution	21
Smart Building Management via LoRaWAN Solution	23
Elevator IoT Solution	25

Marine 27

Marine Cybersecurity Solution	29
-------------------------------	----

Transportation & Logistics 31

Cold Chain Logistics Remote Monitoring Solution	33
Bus Passenger Wi-Fi Solution	35
Autonomous Shuttle Bus Networking Solution	37

Industrial IoT 39

Industrial Robot Networking Solution	41
CNC Machine Remote Maintenance Solution	43
Industrial AGV Networking Enhanced Solution	45
Machine Builder PLC Remote Connectivity Solution	47

Oil, Gas & Mining 49

Urban Natural Gas Pipeline Remote Monitoring Solution	51
---	----

Enterprise IT 53

Enterprise Branch Disaster Recovery 5G Networking Solution	55
Bank Branch 5G Connectivity Solution	59

Retail & Payments 61

Bank ATM Machine Networking Solution	63
Self-service Coffee Machine Networking Solution	65
Digital Signage Networking Solutions	67
Self-service Parcel Locker Networking Solution	69

Agriculture 71

Farmland Water-saving Irrigation Solution	73
Agricultural Greenhouse Monitoring System Solution	75
Smart Farm Network Connection Solution	77

Environmental IoT 79

Waste Water Treatment Solution	81
Hydrometeorological Station Remote Monitoring System Solution	83
Earthquake Monitoring System Solution	85

Healthcare 87

Medical Equipment Maintenance Solution	89
5G+Ambulance Networking Solution	91
Telemedicine Solution	93

Case Study 95

Checkpoint & Robustel – Roll Out Coast-to-coast 4G for USA Retailer	97
Cold-chain Monitoring of Vaccines in Vehicles & Buildings	101
The PFM Experience Centre on Wheels	105
Intelligent Robotic Feeding System for Machinery Production Plant	109



01 Company Overview

Company Introduction

Robustel is a cellular router & Gateway manufacturer specialising in 5G, 4G/LTE & LPWAN devices. Our products are used in smart cities, transportation, utilities, energy, Industrial IoT and many other applications to deliver robust and reliable connectivity.

Data Highlights



Brand Philosophy

"Robustel" is composed of "Robust" and "Tel". "Robust" represents robustness in automation systems, which refers to the high reliability and robustness of the system, while "Tel" represents communication. Together, it means that Robustel provides highly reliable and robust communication products and systems in the industrial internet of things (IIoT). At a macro level, the people at Robustel are highly reliable and trustworthy, and the products and services they design must also be highly reliable.

Robustel Industrial IoT Product

Main Product

Industrial Wireless Communication Device

Edge Computing Gateway

Agriculture, Enterprise IT, Industrial IoT, Transport & Logistics, Smart Cities, Healthcare, Oil, Gas & Mining, Retail & Payments, Energy & Utilities, Environmental IoT

Make Things Connected

Typical Applications

Energy & Utilities

Managing the reading, collection and distribution of traditional and renewable resources for consumer and business use.



Smart Cities

Empowering councils and governments with connectivity for infrastructure, buildings, public spaces and traffic management.



Enterprise IT

Primary internet access or fixed line failover connectivity for distributed office, retail or branch environments.



Industrial IoT

Monitoring & managing assets, equipment and infrastructure in manufacturing, warehousing and construction.



Oil, Gas & Mining

Employing remote control and management to improve safety and efficiency around the extraction of primary resources.



Transport & Logistics

In-Vehicle internet access for fleet management, logistics, public Wi-Fi, security and telematicdata.



Retail & Payments

Wireless Monitoring and Communications for ATMs, Vending Machines, Kiosks, Digital Signage and Point of Sale systems.



Agriculture

Using sensing & wireless technology to improve irrigation, fertilization, yield and more in agriculture and farming.



Environmental IoT

Environmental protection solutions for local conditions to realize intelligent environmental monitoring, disaster prevention and environmental compliance.



Healthcare

Powering remote diagnostics, telemedicine solutions through wireless communications.





Energy & Utilities

Managing the reading, collection and distribution of traditional and renewable resources for consumer and business use.

Electricity Distribution Network Intelligent FTU Networking Solution

Demands & Pain Points

- Reliable wireless connectivity is critical for power companies to gather real-time data from intelligent feeder terminal units (FTUs) and regulate and monitor electricity distribution operations.
- Industrial-grade networking devices are necessary for distribution network facilities to perform consistently under harsh weather conditions like extreme temperature and humidity, etc.
- To improve maintenance efficiency and reduce power outages, gateways must provide real-time fault alarm reports to quickly identify and correct faults in the large number of FTUs located across dispersed locations. Traditional fault identification methods are inefficient.

Solution

Robustel IIoT Gateway connects to the distribution network's intelligent feeder terminal unit (FTU) through the RS-485 serial port. The gateway collects FTU operating data and uploads it to the operation center through 4G LTE network. This solution effectively improves the efficiency of FTU management by the power company and ensures the stable operation of the power grid.

Stable Connection

Robustel IIoT Gateway provides cellular network wireless networking, uninterrupted data transmission for various networking scenarios.

High Reliability

The device has passed rigorous tests to ensure it can withstand harsh environmental impacts and ensure stable data transmission.

Remote Operation and Maintenance

Robustel's RCMS device management platform provides remote, real-time monitoring and diagnosis, allowing maintenance staff to work off-site.

Topology

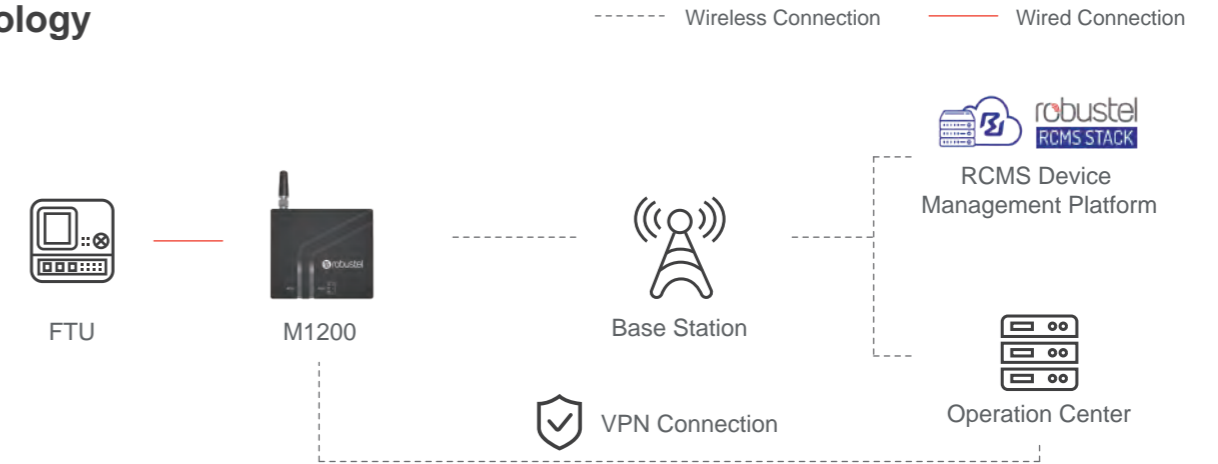

Advantages



Robust Industrial Design

Robustel's quality products have industrial housing for reliability in any conditions, and protect against humidity, dust, vibration and EMC.



Dual SIM Card Design

Dual SIM backup enhances network resilience - 2 networks are better than 1!



Serial Ports Onboard

RS232/485 support for Modbus RTU interface, connecting thousands of sensors/instruments for maximum flexibility.



Customer-hosted Router Management Platform

RCMS router management platform can create a private "walled garden" when installed on customer's data center or cloud infrastructure for excellent router management.

Recommended Product



M1200

Urban Water Supply Pipeline Monitoring Solution

Demands & Pain Points

- Urban water supply pipelines pose challenges due to their extensive distribution, complex environment, and multiple nodes. Maintenance personnel encounters difficulty when locating fault points, leading to prolonged water outage upon water supply failures.
- Regular monitoring of water pressure and flow data is vital to ensure the optimal operation of urban water supply pipelines. Water companies must make dynamic adjustments based on monitoring data to maintain the optimal water supply system.

Solution

The controller (RTU) of the pipeline monitoring end is connected to water pressure, flow sensor, and solenoid valve through the line. The RTU is connected to the Robustel industrial IoT gateway through the RS-485 serial port. The gateway collects information such as water pressure, flow rate, and solenoid valve status sent by the RTU and transmits it to the monitoring center through a 4G LTE cellular network, providing timely and reliable data basis for effective management of urban water supply pipelines.

Stable Connection

Robustel IIoT Gateway provides cellular network wireless networking, uninterrupted data transmission for various networking scenarios.

Flexible Configuration

RobustOS Pro offers diversified device management methods, supporting configuration through SMS, Web, CLI, cloud platform, and more even in complex scenarios.

Remote Operation and Maintenance

Robustel's RCMS device management platform provides remote, real-time monitoring and diagnosis, allowing maintenance staff to work off-site.

Topology

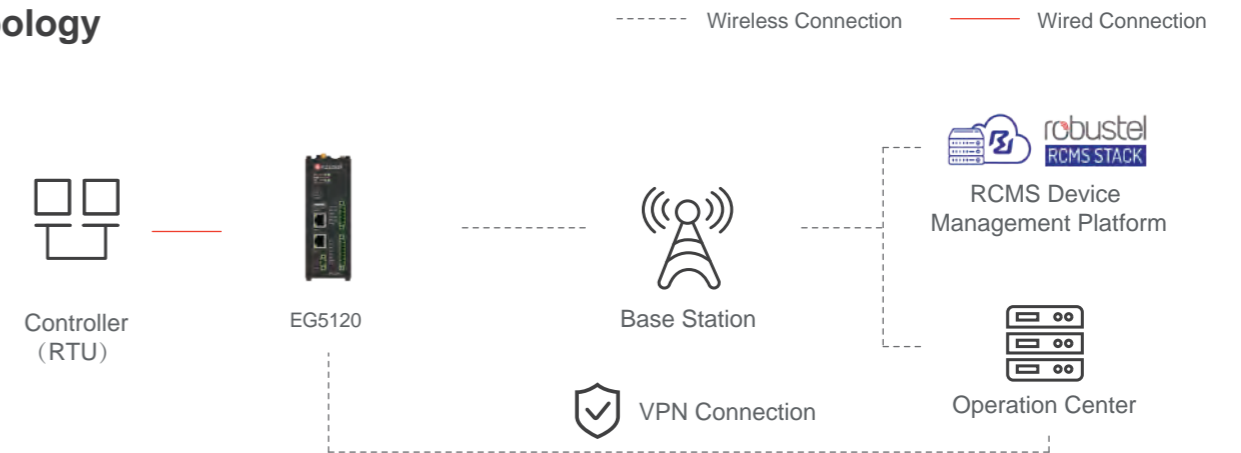

Advantages



Robust Industrial Design

Robustel's quality products have industrial housing for reliability in any conditions, and protect against humidity, dust, vibration and EMC.



Edge Computing Capabilities

high-performance hardware provides a strong foundation for information processing and complex task handling.



Dual SIM Card Design

Dual SIM backup enhances network resilience - 2 networks are better than 1!



Free Router Management Platform

RCMS router management platform manages SIMs and routers at scale. Free basic version, advanced features on PAYG - compelling commercially.

Recommended Product



EG5120

Wind Turbine Preventive Maintenance Solution

Demands & Pain Points

- Wind turbines are located in challenging areas, making their installation and maintenance complex and costly. However, using sensors for preventive maintenance can help reduce costs.
- Wireless cellular communication products must meet global certification requirements and meet stringent product quality and environmental requirements for preventive maintenance solutions for wind power plants.

Solution

Robustel provides R1520-4L Global, the Global Single SKU product, to customers:

- Single SKU for Global Frequency Bands** | Supports global frequency bands and offers a single SKU, simplifying device selection, stocking, and logistics while reducing operating costs for global deployments.
- Global Certifications** | Achieved market certifications in most countries, including Europe (CE), US (FCC/PT-CRB/AT&T/VERIZON), Canada (IC), Brazil (ANATEL), Japan (JATE/TELEC), and Australia (RCM), lowering compliance risks for customers.
- Remote Device Management** | RCMS device management platform provides fast real-time monitoring, remote diagnosis, enabling equipment maintenance work to be completed without visiting the site.
- Security and Reliability** | Nettitude, a well-known global cybersecurity lab, tested and approved RobustOS as a gateway operating system for IoT applications.

Topology

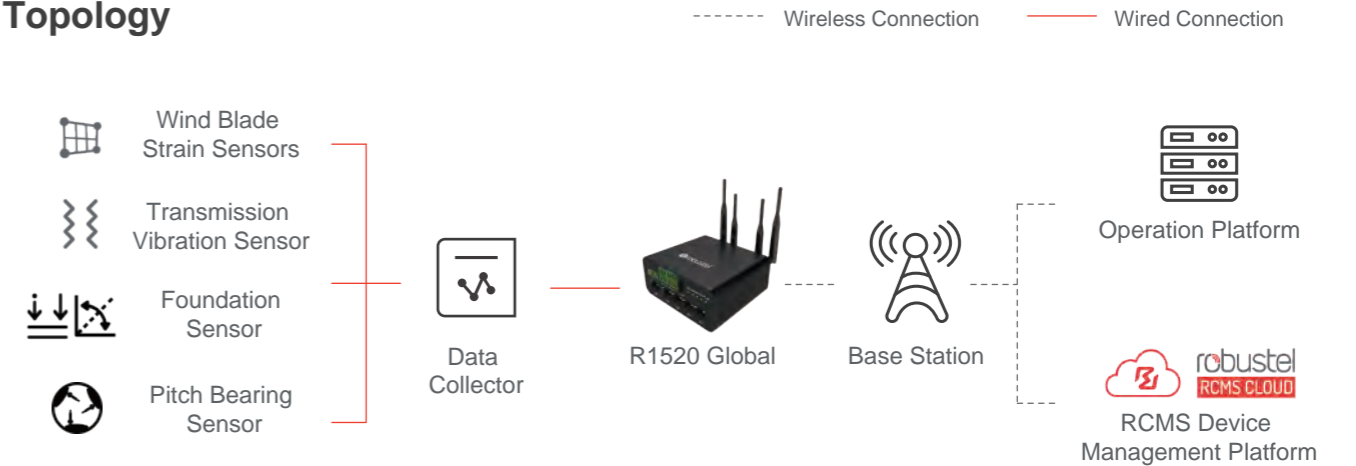

Advantages

- Robust Industrial Design** | Robustel's quality products have industrial housing for reliability in any conditions, and protect against humidity, dust, vibration and EMC.
- Extensive International Certifications** | Robustel heavily invests in global certifications for Robustel's Global IoT Router, making it one of the most certified worldwide.
- Serial Ports & Digital IO & Analog Input Onboard** | Support for legacy serial devices with RS-232/RS-485 interfaces provides maximum flexibility when used as a Modbus RTU interface, with IO and analog inputs.
- Free Router Management Platform** | RCMS router management platform manages SIMs and routers at scale. Free basic version, advanced features on PAYG - compelling commercially.

Recommended Product



R1520 Global

Smart Grid Solar Power Station Monitoring Solution

Demands & Pain Points

- Solar power stations are typically situated in secluded, sun-drenched regions with arid climates, and must withstand harsh conditions like extreme temperature fluctuations and sand and dust exposure. To guarantee uninterrupted power supply and optimize solar energy harvest, solar power stations require robust, industrial-grade equipment.
- These stations are typically fitted with numerous photovoltaic panels, which collect vast amounts of data that necessitates preprocessing for effective data extraction. This is crucial for efficient reporting to the management platform.

Solution

The photovoltaic power generation panel is connected to the Robustel edge computing gateway through LoRa, and the gateway provides a data transmission channel between the photovoltaic power station and the management platform through the wireless cellular network. Administrators can complete the monitoring and management of photovoltaic power plants through the management platform.

High Reliability | The device has passed rigorous tests to ensure it can withstand harsh environmental impacts like high/low temperature, and ensure stable data transmission with automated operation and maintenance supported.

Edge Computing | Robustel Edge Computing Gateway features a high-performance CPU, improving computing power for optimized, real-time, and intelligent analysis of on-site equipment data.

Remote Operation and Maintenance | RCMS device management platform provides fast real-time monitoring, remote diagnosis, enabling equipment maintenance work to be completed without visiting the site.

Topology

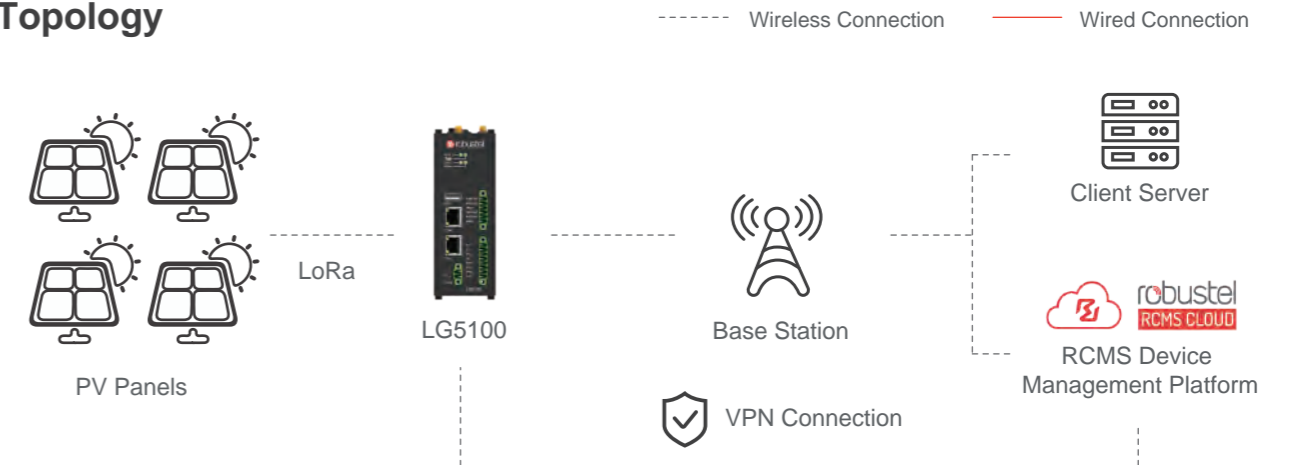

Advantages

Built-in Web Server

Feature a built-in web server, eliminating the need for costly cloud server operations.

Supports Docker

Robustel's Docker containerisation allows easily porting of software to EG5000 series Gateways from other platforms.

Serial Ports & Digital IO Onboard

Support for legacy serial devices with RS-232/RS-485 interfaces provides maximum flexibility when used as a Modbus RTU interface, with IO for status indication and control.

Free Router Management Platform

RCMS router management platform manages SIMs and routers at scale. Free basic version, advanced features on PAYG - compelling commercially.

Recommended Product



LG5100

EV Charging Pile Networking Solution

Demands & Pain Points

- The deployment of car charging piles is increasing due to the popularity of new energy vehicles. To better manage charging piles and improve service quality, it is necessary to have them networked.
- Charging piles are exposed to the outdoor environment and some facilities have complex on-site environments, which require industrial-grade networking equipment to withstand the effects of harsh conditions.
- Mobile payment methods have been added to charging piles, requiring secure and reliable internet connectivity.
- Most parking lots deploy multiple charging piles, which require a reliable monitoring and management platform.

Solution

The charging pile communicates with the Robustel IIoT Gateway through the Ethernet port, and the router establishes a seamless connection with the monitoring cloud platform through a stable and reliable 4G LTE cellular wireless network. Combined with routing strategies, VPN tunnels and other functions, it provides safe network access and real-time services for the charging pile.

Stable Connection

Robustel IIoT Gateway provides cellular network wireless networking, uninterrupted data transmission for various networking scenarios.

Security and Reliability

Nettitude, a well-known global cybersecurity lab, tested and approved RobustOS as a gateway operating system for IoT applications.

Integrated Management

Robustel's RCMS platform enables simultaneous management of multiple devices, reducing the time spent managing them.

Topology

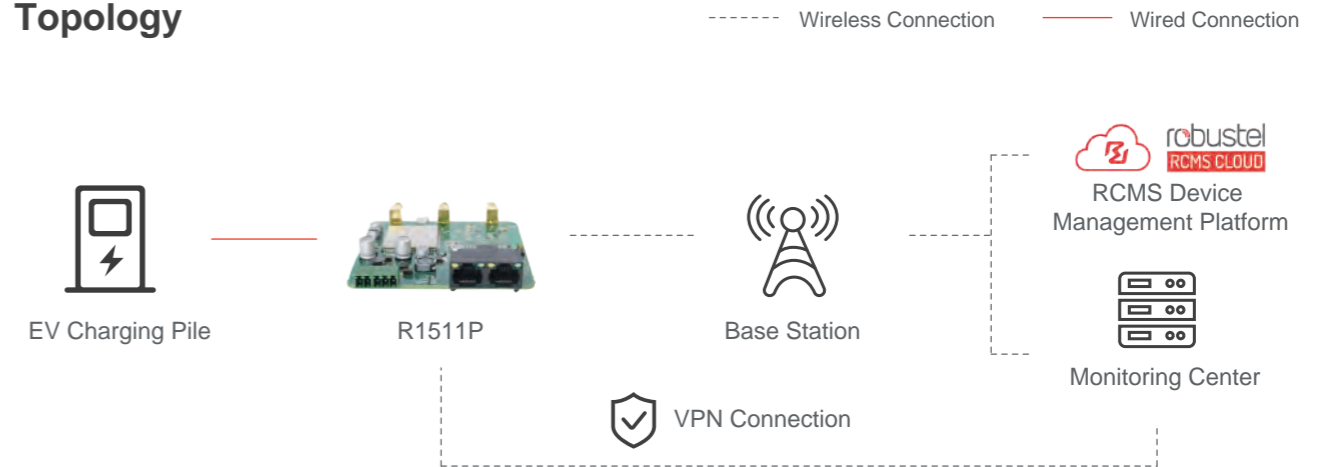

Advantages



Cost-effective Hardware

Robustel hardware: Industrial grade, durable, wide voltage/temperature range, cost-effective for high volume Industrial/IoT rollouts.



Designed for Embedded Applications

An ideal solution for embedded applications to customers who need to purchase in large quantities while minimizing procurement costs.



Serial Ports Onboard

RS232/485 support for Modbus RTU interface, connecting thousands of sensors/instruments for maximum flexibility.



Free Router Management Platform

RCMS router management platform manages SIMs and routers at scale. Free basic version, advanced features on PAYG - compelling commercially.

Recommended Product



R1511P

Smart Cities

Empowering councils and governments with connectivity for infrastructure, buildings, public spaces and traffic management.

Urban Road Traffic Monitoring Solution

Demands & Pain Points

- Real-time traffic monitoring is crucial for urban traffic management departments to identify congestion and disruptions, enabling proactive measures to alleviate issues and improve efficiency.
- An efficient urban traffic management solution should utilize intelligent traffic lights to optimize flow, minimize congestion, and reduce accidents and delays by adjusting signal timings based on real-time traffic conditions.
- Urban traffic management departments require digital traffic guidance signs to offer real-time information on alternative routes, traffic conditions, and diversions. This helps drivers make informed decisions and navigate the road network more efficiently.

Solution

Monitoring equipment, signal lights, digital signage, and other devices are connected to the Robustel IIoT Gateway through RS-485 serial ports or Ethernet cables. The gateway transmits the data in real time through high-speed 5G network to the monitoring center. The monitoring center analyzes and processes these data, and promptly identifies and handles abnormal events to ensure smooth traffic flow on city roads.

High-speed Connectivity

Offers flexible connectivity including 5G/4G/3G cellular networks, Wi-Fi, wired connections and link management function to ensure reliable, high-speed data transmission.

High Reliability

The device has passed rigorous tests to ensure it can withstand harsh environmental impacts and ensure stable data transmission.

Fast Market Entry

Obtained market access certifications in multiple countries worldwide, such as CCC, CE and RCM, which helps customers rapidly complete network access deployment.

Topology



Advantages



Cost-effective Hardware

Robustel hardware: Industrial grade, durable, wide voltage/temperature range, cost-effective for high volume Industrial/IoT rollouts.



High-speed Connection

Robustel's 5G routers support 5G Release 16 with fast DL/UL speeds in NSA/SA modes. 4G+ Carrier Aggregation ensures fast connections without 5G.



Serial Ports Onboard

RS-232/485 support for Modbus RTU interface, connecting thousands of sensors/instruments for maximum flexibility.



Free Router Management Platform

RCMS router management platform manages SIMs and routers at scale. Free basic version, advanced features on PAYG - compelling commercially.

Recommended Product



R5020 Lite

Urban CCTV Solution

Demands & Pain Points

- The public security department is responsible for resident safety and has taken measures, such as installing video surveillance equipment, to achieve this goal. This equipment allows for better allocation of resources and more effective protection for residents.
- However, the installation of video surveillance equipment presents challenges in regards to transmission bandwidth. Fixed network cabling is expensive, but a cost-effective solution is the use of 5G cellular wireless network transmission. This technology can greatly improve resident security.

Solution

The surveillance equipment is connected to the Robustel Edge Computing Gateway via Ethernet cable, and the gateway collects and pre-processes the surveillance images. The images are then transmitted to the monitoring platform via 5G high-speed transmission, enabling precise investment in urban security and accelerating the informationization transformation of urban security management.

High-speed Connectivity

Offers flexible connectivity including 5G/4G/3G cellular networks, Wi-Fi, wired connections and link management function to ensure reliable, high-speed data transmission.

High Reliability

The device has passed rigorous tests to ensure it can withstand harsh environmental impacts and ensure stable data transmission.

Remote Operation and Maintenance

RCMS device management platform provides fast real-time monitoring, remote diagnosis, enabling equipment maintenance work to be completed without visiting the site.

Topology



Advantages



Robust Industrial Design

Robustel's quality products have industrial housing for reliability in any conditions, and protect against humidity, dust, vibration and EMC.



High-speed Connection

Robustel's 5G routers support 5G Release 16 with fast DL/UL speeds in NSA/SA modes. 4G+ Carrier Aggregation ensures fast connections without 5G.



High-precision Positioning

Provides precise location via GNSS and accurate navigation.



Free Router Management Platform

RCMS router management platform manages SIMs and routers at scale. Free basic version, advanced features on PAYG - compelling commercially.

Recommended Product



EG5120

Smart Building Management via LoRaWAN Solution

Demands & Pain Points

- IoT deployments for Building Management Systems (BMS) frequently encounter obstacles like limited connectivity options, high deployment costs, scalability issues, and power constraints. These challenges can hinder the effective monitoring and management of building systems.

Solution

The Robustel R1520LG LoRaWAN gateway provides a solution by enabling long-range, low-power wireless connectivity for sensors and devices deployed throughout the building.

By leveraging LoRaWAN technology, BMS IoT deployments can overcome connectivity limitations, reduce deployment costs, scale efficiently, and extend battery life for sensor devices. LoRaWAN gateways facilitate real-time monitoring and analysis of building conditions, enabling proactive management and optimization of building operations.

Support LoRaWAN Globally

Supporting global LoRa frequencies with the Semtech SX1302 solution.

Chirpstack + E2C

Featuring embedded Chirpstack LNS and Robustel's Edge2Cloud framework, the solution manages data from the LoRa node to mainstream clouds without requiring additional software development work.

Remote Operation and Maintenance

The RCMS device management platform offers fast real-time monitoring and remote diagnosis, enabling equipment maintenance work to be completed without the need for site visits.

Topology

APPLICATION EXAMPLE

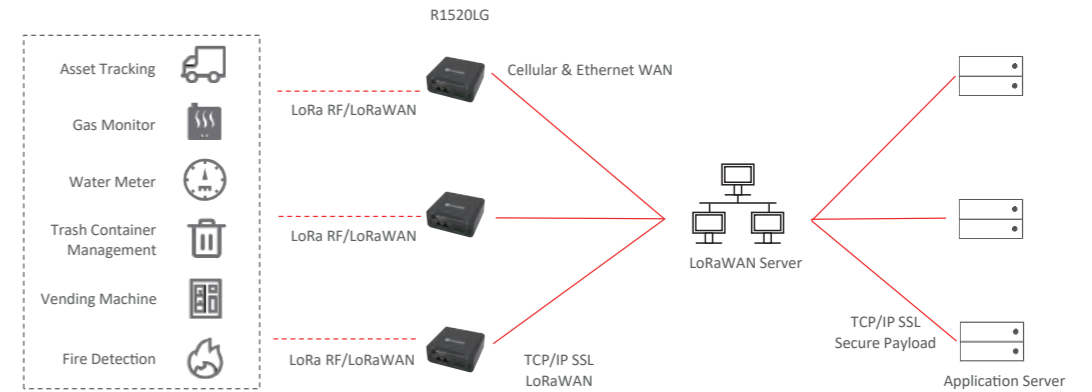

Advantages



Multi-Interface

2 x Ethernet, 1 x RS232, 1 x RS485, allowing connection to more field devices.



Dual SIM Card Design

Dual SIM backup enhances network resilience - 2 networks are better than 1!



Edge Computing Capability

The i.MX 6ULL and 512M DDR3 high-performance hardware provides a strong foundation for information processing and complex task handling.



Free Router Management Platform

RCMS router management platform manages SIMs and routers at scale. Free basic version, advanced features on PAYG - compelling commercially.

Recommended Product



R1520LG

Elevator IoT Solution

Demands & Pain Points

- In the elevator industry, safety reigns supreme. Reliable and efficient communication systems are the lifeline for passenger safety, making seamless and uninterrupted communication indispensable, especially during emergencies. With safety at the heart of elevator operations, ensuring continuous connectivity becomes paramount.

Solution

The Robustel EV8100 stands as the ultimate solution for elevator voice communication, ensuring unparalleled safety for passengers and providing a cost-effective solution for companies.

Uninterrupted Power Supply

Backup power is provided by installed lithium batteries, ensuring continuous connectivity even during power outages.

Highly Stable Connectivity

Upgrade from PSTN to VoIP/VoLTE Cellular Network effortlessly. Dual SIM card slots ensure redundant communications, delivering reliable cellular connectivity with global band coverage.

Remote Operation and Maintenance

The RCMS device management platform offers fast real-time monitoring and remote diagnosis, enabling equipment maintenance work to be completed without the need for site visits.

Edge Computing

The EV8100 features a high-performance CPU, enhancing computing power for optimized, real-time, and intelligent analysis of on-site elevator data.

Topology

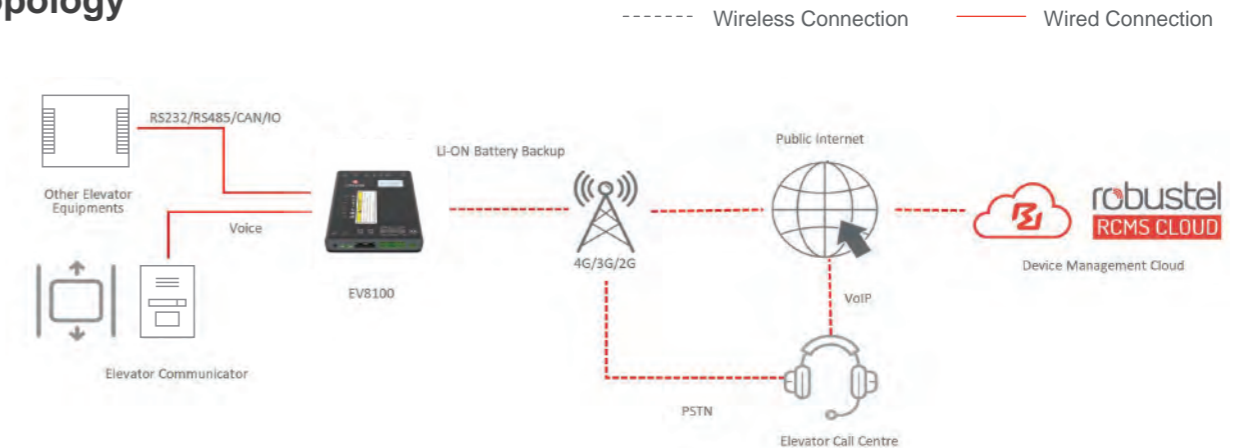

Advantages

Serial Ports & CAN

Allow customers to connect with different sensors and controllers in the elevator machine room.

Elevator Standard Compliance

Comply with EN81-28 and AS1735 standards in one hardware unit.

Edge Computing Capability

The i.MX 6ULL and 512M DDR3 high-performance hardware provides a strong foundation for information processing and complex task handling.

Free Router Management Platform

RCMS router management platform manages SIMs and routers at scale. Free basic version, advanced features on PAYG - compelling commercially.

Recommended Product



EV8100



Marine

Marine Cybersecurity Solution

Demands & Pain Points

- Emerging technologies such as Low Earth Orbit satellite communications, electric propulsion, and unmanned vessels are transforming the ocean into a highly interconnected digital space, posing new challenges to the safety of maritime navigation and the stability of global shipping.
- To address these challenges, the International Association of Classification Societies (IACS) released the UR E26 and E27 cybersecurity resilience standards in 2022. IACS UR E26/27 class approval is mandatory for vessels whose design and build contracts are signed on or after July 1, 2024.
- These standards aim to ensure safe navigation in the digital age through strict cybersecurity requirements. They set out specific guidelines and certification processes for shipowners and operators, detailing the normative requirements that onboard computer systems, networks, and equipment must follow.

Solution

Robustel launched an end-to-end marine cybersecurity solution in May 2024 that meets IEC61162-460 standards which specified in E27 for navigation system, radio communication and interconnected networks.

Cybersecurity Passport	The MG460 enables system manufacturers and integrators to obtain a "cybersecurity passport" for their systems, streamlining time to market, reducing risks, and lowering costs.
Internal DMZ and Edge Computing	The MG460 provides a Debian 11-based edge computing platform, empowering customers to install their software in a secure internal DMZ zone. This simplifies applications and reduces total ownership costs.
End to End Secure Network	Robustel offers RCMS Stack Marine and the MG460 to establish VPN-based secure connections between a vessel's trusted network and external networks, meeting E26 and E27 requirements.

Topology

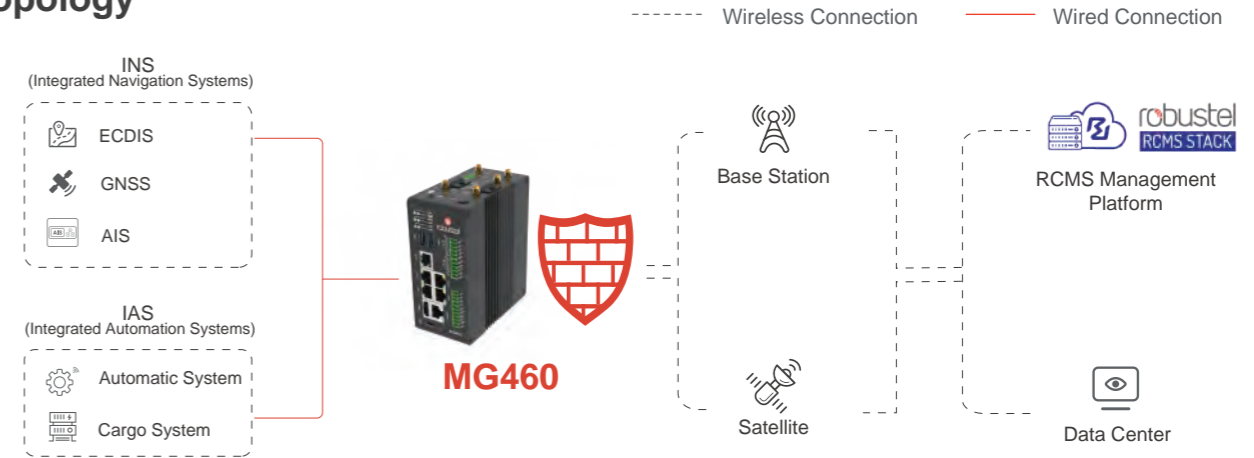

Advantages

- Maritime Standard Compliance**: Compliance with IEC 60945 and latest IEC 61162-460 edition 3 standards
- Multiple Interfaces**: Provides various interfaces (Serial/USB, I/O, Gigabit Ethernet ports) to connect on-vessel devices and systems.
- Secure Networking Solution**: internal DMZ zone + VPN-based secure connections between a vessel's trusted network and external networks
- Customer-hosted Router Management Platform**: RCMS router management platform can create a private "walled garden" when installed on customer's data center or cloud infrastructure for excellent router management.

Recommended Product



MG460



Transportation & Logistics

In-Vehicle internet access for fleet management, logistics, public Wi-Fi, security and telematic data.

Cold Chain Logistics Remote Monitoring Solution

Demands & Pain Points

- To meet the increasing need for cold chain transportation in e-commerce and enhance operational efficiency of cold chain vehicles, logistics companies must manage vehicles, monitor temperature, and track vehicle data in real-time.

Solution

The Robustel IIoT Gateway is connected to the controller of the cold chain truck via an RS-232 serial port. The gateway collects operational status data from the controller in real time, compresses the data and uploads it to the management platform via 4G LTE cellular wireless network. Based on the data reported by the gateway, the management platform realizes efficient, convenient and reliable overall management of the vehicle.

Stable Connection Robustel IIoT Gateway provides cellular network wireless networking, uninterrupted data transmission for various networking scenarios.

High Reliability The device has passed rigorous tests to ensure it can withstand harsh environmental impacts and ensure stable data transmission.

Integrated Management Robustel's RCMS platform enables simultaneous management of multiple devices, reducing the time spent managing them.

Topology

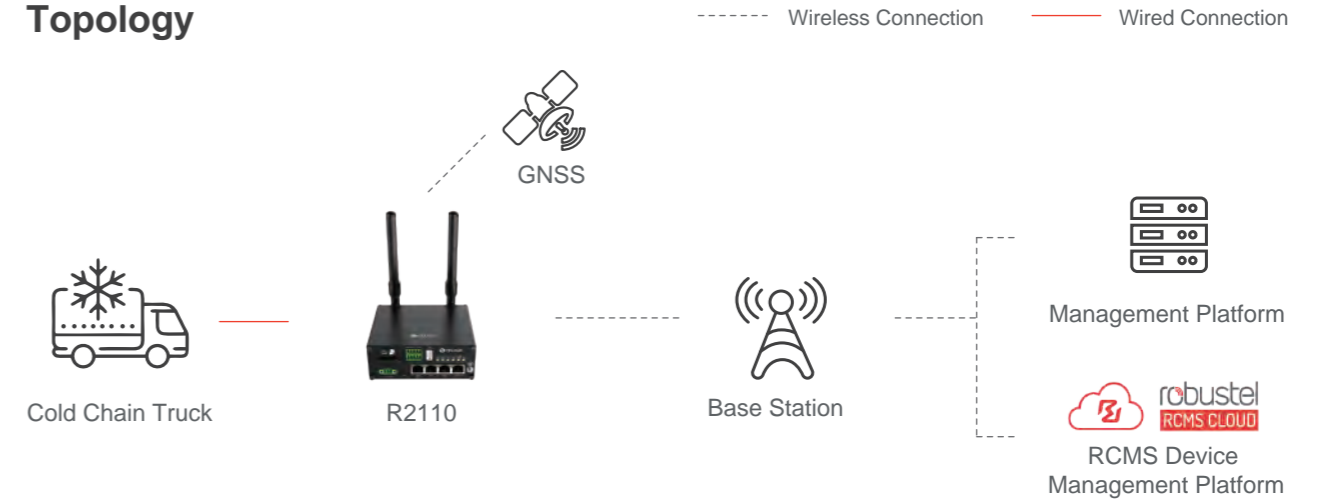

Advantages

- Robust Industrial Design** Robustel's quality products have industrial housing for reliability in any conditions, and protect against humidity, dust, vibration and EMC.
- ACC Support** Optional support for vehicle accessory (ACC) power supplies with ignition sense.
- Serial Ports & Digital IO Onboard** Support for legacy serial devices with RS232/RS485 interfaces provides maximum flexibility when used as a Modbus RTU interface, with IO for status indication and control.
- Vehicle Certification** Achieved the "E-mark" certification, proving its suitability for use in both private and commercial vehicles.

Recommended Product



R2110

Bus Passenger Wi-Fi Solution

Demands & Pain Points

- Demand for seamless connectivity: Transportation companies require a next-generation passenger Wi-Fi system that delivers reliable, high-speed connectivity throughout the journey to meet the expectations of tech-savvy travelers.
- Improved passenger experience: Providing fast and stable internet access allows passengers to stay connected and entertained during their journey, leading to increased customer satisfaction and loyalty.
- Data collection and analytics: Transportation companies seek a Wi-Fi system that captures passenger data for analysis, enabling insights to personalize offerings, optimize services, and improve operational efficiency.

Solution

The bus provides on-board power supply access, and the Robustel IIoT Gateway is connected to the Internet through a cellular network. It provides high-speed Wi-Fi access services for bus passengers through 2.4 GHz or 5 GHz Wi-Fi. The bus company management platform can understand the device's Internet access information and cellular data consumption in real time through the RCMS device management platform.

Intelligent Switching

RobustOS link management function detects network connections in real time and quickly switches to another backup network link, reducing network connection interruption time.

Content Filtering

Robustel have integrated with www.cleanbrowsing.org to provide a powerful, flexible and very cost-effective content filtering service, awarded the "Friendly Wi-Fi" seal of approval.

Remote Operation and Maintenance

RCMS device management platform provides fast real-time monitoring, remote diagnosis, enabling equipment maintenance work to be completed without visiting the site.

Topology

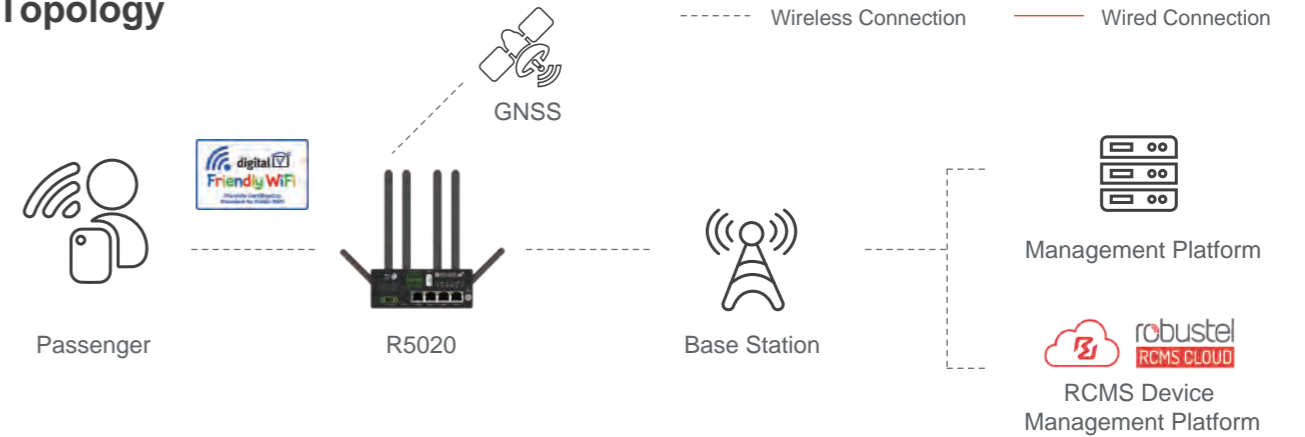

Advantages

- Flexible 802.11 Wi-Fi Services**

Robustel routers offer Wi-Fi client, AP and dual modes, with advanced onboard firewall.
- High-speed Connection**

Robustel's 5G routers support 5G Release 16 with fast DL/UL speeds in NSA/SA modes. 4G+ Carrier Aggregation ensures fast connections without 5G.
- Vehicle Certification**

Achieved the "E-mark" certification, proving its suitability for use in both private and commercial vehicles.
- Free Router Management Platform**

RCMS router management platform manages SIMs and routers at scale. Free basic version, advanced features on PAYG - compelling commercially.

Recommended Product



R5020

Autonomous Shuttle Bus Networking Solution

Demands & Pain Points

- The future of transportation lies in autonomous driving, which relies heavily on fast, stable, and reliable data connections. Such connections are essential for autonomous driving solution providers to collect real-time operational data. This valuable data provides support for continuous iteration and improvement of automated driving algorithms.
- Efficient network management ensures minimal downtime, reduces support costs, and contributes to a seamless passenger experience. Additionally, the ability to centrally manage the network allows for easier scalability and future expansion of services.

Solution

The camera, LiDAR, radar, and other sensors are connected to the bus controller, which in turn is connected to the Robustel 5G IoT Router using an Ethernet cable. The data from these sensors is then forwarded by the router through a high-speed 5G cellular network to the management platform. Through the RCMS platform, the real-time location of devices can be displayed, providing autonomous driving companies with effective data support for the management of autonomous shuttle buses.

High-speed Connectivity

Offers flexible connectivity including 5G/4G/3G cellular networks, Wi-Fi, wired connections and link management function to ensure reliable, high-speed data transmission.

High Reliability

The device has passed rigorous tests to ensure it can withstand harsh environmental impacts and ensure stable data transmission.

Remote Operation and Maintenance

Robustel's RCMS device management platform provides remote, real-time monitoring and diagnosis, allowing maintenance staff to work off-site.

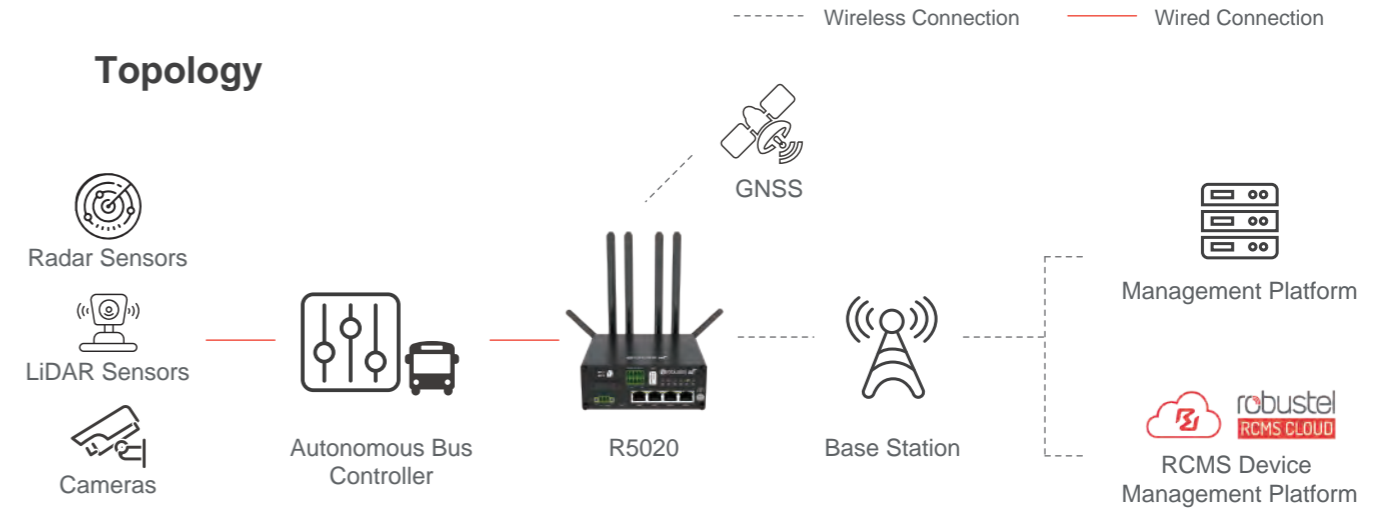

Advantages



Cellular Connection Keepalive

Robustel's cellular keepalive monitors and recovers from connectivity loss between routers and mobile networks.



High-speed Connection

Robustel's 5G routers support 5G Release 16 with fast DL/UL speeds in NSA/SA modes. 4G+ Carrier Aggregation ensures fast connections without 5G.



Vehicle Certification

Achieved the "E-mark" certification, proving its suitability for use in both private and commercial vehicles.



Free Router Management Platform

RCMS router management platform manages SIMs and routers at scale. Free basic version, advanced features on PAYG - compelling commercially.

Recommended Product



R5020



Industrial IoT

Monitoring & managing assets, equipment and infrastructure in manufacturing, warehousing and construction.

Industrial Robot Networking Solution

Demands & Pain Points

- Industrial robotic arms in factories need wireless networks instead of traditional wiring to save costs and ensure safety.
- The large amount of data from robotic arms requires stable, low-latency transmission that traditional methods cannot provide.
- Factory LAN limits data monitoring to a small area and makes remote maintenance difficult, causing high maintenance costs.

Solution

The industrial robotic arm is connected to the Robustel IIoT Gateway through a serial port. The gateway connects to the operation platform and Robustel RCMS device management platform through a private 5G high-speed network provided by the operator, and collects and reports real-time operational data from the robotic arm, thus improving the professional maintenance service capability with high quality.

High-speed Connectivity | Offers flexible connectivity including 5G/4G/3G cellular networks, Wi-Fi, wired connections and link management function to ensure reliable, high-speed data transmission.

Real-time Collection | RobustOS Pro can run Edge2Cloud applications to collect and upload terminal data, allowing administrators to access real-time on-site data through the cloud platform.

Topology

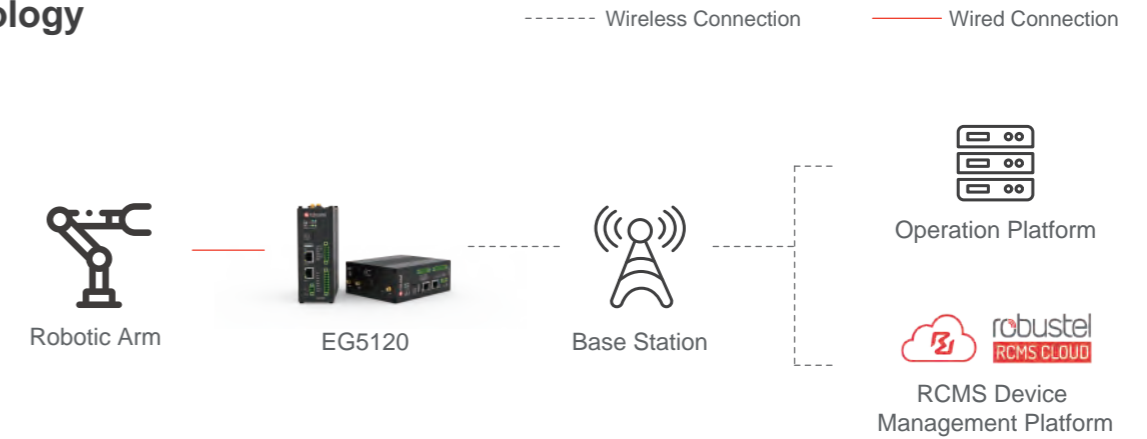

Advantages

- Unique (E2C) Edge2Cloud Software** | Support for powerful Edge2Cloud IoT Gateway via innovative software, used in many Modbus to Cloud projects.
- Support for Custom Applications** | RobustOS and RobustOS Pro have SDKs for running supplementary software on router resources, saving the cost of an embedded PC.
- Supports Docker** | Robustel's Docker containerisation allows easily porting of software to EG5000 series Gateways from other platforms.
- Flash Manager Tool** | Robutel's EG5000 series gateways have a storage management tool that minimizes NAND Flash wear out in customer applications.

Recommended Product



EG5120

CNC Machine Remote Maintenance Solution

Demands & Pain Points

- CNC machine tools are complex products that use many technologies. But the information they generate is often not accessible.
- Technical maintenance professionals can only work on the equipment onsite. This adds to operating and maintenance expenses for companies.
- Downtime from equipment failure can hurt production. Delays in addressing malfunctions and making repairs further cut into capacity.

Solution

The CNC machine is connected to the Robustel IIoT Gateway through a serial port. The gateway uses 5G high-speed cellular private network to transmit the operating data of the CNC machine tool to the RCMS device management platform. The complete solution consists of both software and hardware, including the RCMS device management platform's ability to establish data synchronization connections with customer operation centers and the RCMS.

High-speed Connectivity

Offers flexible connectivity including 5G/4G/3G cellular networks, Wi-Fi, wired connections and link management function to ensure reliable, high-speed data transmission.

Edge Computing

Robustel Edge Computing Gateway features a high-performance CPU, improving computing power for optimized, real-time, and intelligent analysis of on-site equipment data.

Information Transparency

Through the RCMS device management platform, managers can easily access the location of the devices, their current configuration information, and real-time comprehensive on-site information.

Topology

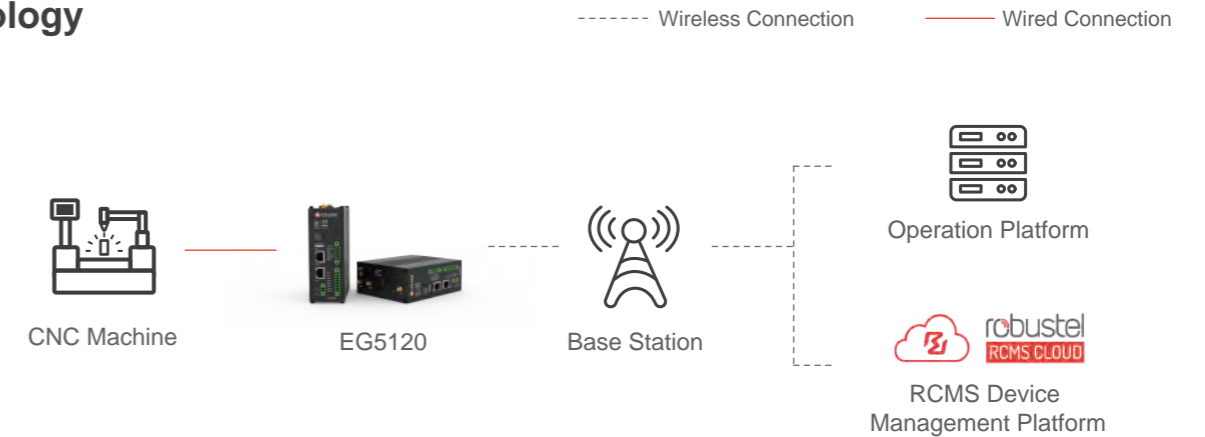

Advantages

- Unique (E2C) Edge2Cloud Software**

Support for powerful Edge2Cloud IoT Gateway via innovative software, used in many Modbus to Cloud projects.
- Support for Custom Applications**

RobustOS and RobustOS Pro have SDKs for running supplementary software on router resources, saving the cost of an embedded PC.
- Supports Docker**

Robustel's Docker containerisation allows easily porting of software to EG5000 series Gateways from other platforms.
- Flash Manager Tool**

Robutel's EG5000 series gateways have a storage management tool that minimizes NAND Flash wear out in customer applications.

Recommended Product



EG5120

Industrial AGV Networking Enhanced Solution

Demands & Pain Points

- Traditional Wi-Fi communication for AGVs with LAN control centers often causes instability and interruptions, negatively impacting production efficiency. An enhanced networking solution is needed to ensure stable and reliable communication, minimizing disruptions and optimizing operational efficiency.
- AGV management in industrial environments requires seamless management across diverse locations, especially outside of the factory area. An enhanced networking solution is needed for efficient control and supervision, enabling seamless management across geographical areas.
- Industrial-grade network equipment requires durable, reliable routers for harsh environments, ensuring uninterrupted connectivity and smooth operation of AGVs in industrial settings, meeting specific demands.

Solution

AGV is connected to the Robustel IIoT Gateway through the Ethernet cable, and the gateway is connected to the Robustel RCMS device management platform via the 5G private network. The platform establishes a seamless connection with the data monitoring center, providing seamless networking and monitoring services for industrial AGVs.

Stable Connection Robustel IIoT Gateway provides cellular network wireless networking, uninterrupted data transmission for various networking scenarios.

Security and Reliability Nettitude, a well-known global cybersecurity lab, tested and approved RobustOS as a gateway operating system for IoT applications.

Real-time Collection RobustOS can run Edge2Cloud applications to collect and upload terminal data, allowing administrators to access real-time on-site data through the cloud platform.

Topology

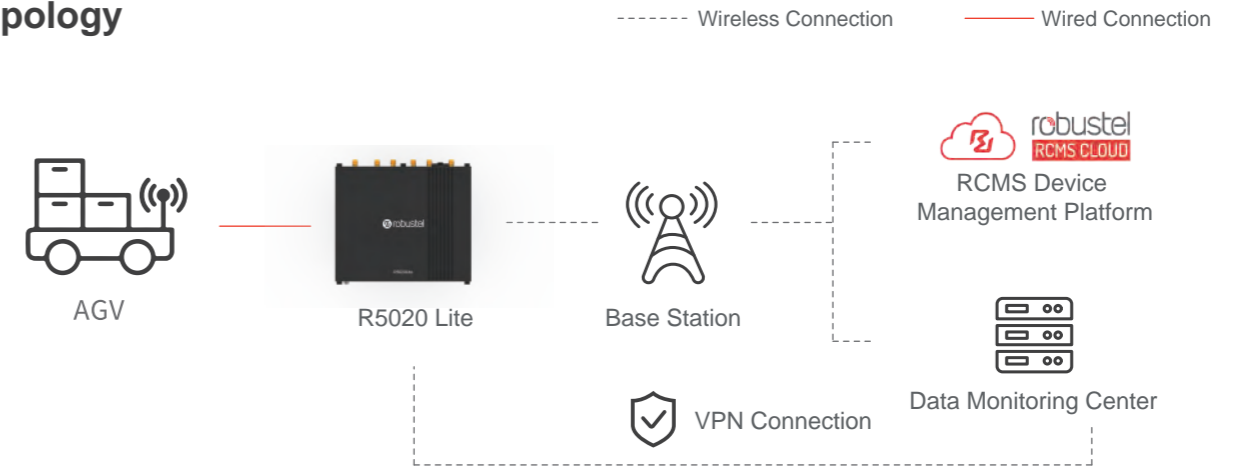

Advantages

Cost-effective Hardware Robustel hardware: Industrial grade, durable, wide voltage/temperature range, cost-effective for high volume Industrial/IoT rollouts.

Flexible 802.11 Wi-Fi Services Robustel routers offer Wi-Fi client, AP and dual modes, with advanced onboard firewall.

Compact Design Small in size and rich in functions, it can meet the installation requirements in narrow spaces.

Cellular Connection Keepalive Robustel's cellular keepalive monitors and recovers from connectivity loss between routers and mobile networks.

Recommended Product



R5020 Lite

Machine Builders PLC Remote Connectivity Solution

Demands & Pain Points

- Machine builders need reliable and efficient connectivity solutions to remotely monitor and troubleshoot their machines to ensure optimal performance and minimize downtime.

- Complex and time-consuming traditional connectivity methods hinder productivity. These methods involve configuring multiple intermediate devices, setting up VPN, and implementing complex network configurations.

- Machine builders must ensure secure connections to PLCs to prevent unauthorized access, data breaches, or tampering. Insufficient or insecure connectivity options can pose significant security risks.

Solution

With the EG5100 Industrial Edge Computing Gateway, machine builders can realize a comprehensive and robust solution for PLC connectivity with applications from Debian repository supported. With RCMS, machine builders can easily configure and deploy VPN connections, streamlining the setup process and reducing human error.

Stable Connection	Robustel Industrial Edge Computing Gateway provides cellular network wireless networking, uninterrupted data transmission for various networking scenarios.
Information Encryption	RobustOS Pro securely establishes VPN encrypted tunnels with the data center through comprehensive security policies, ensuring the security of information transmission.
Remote Device Management	RCMS device management platform provides fast real-time monitoring, remote diagnosis, enabling equipment maintenance work to be completed without visiting the site.

Topology

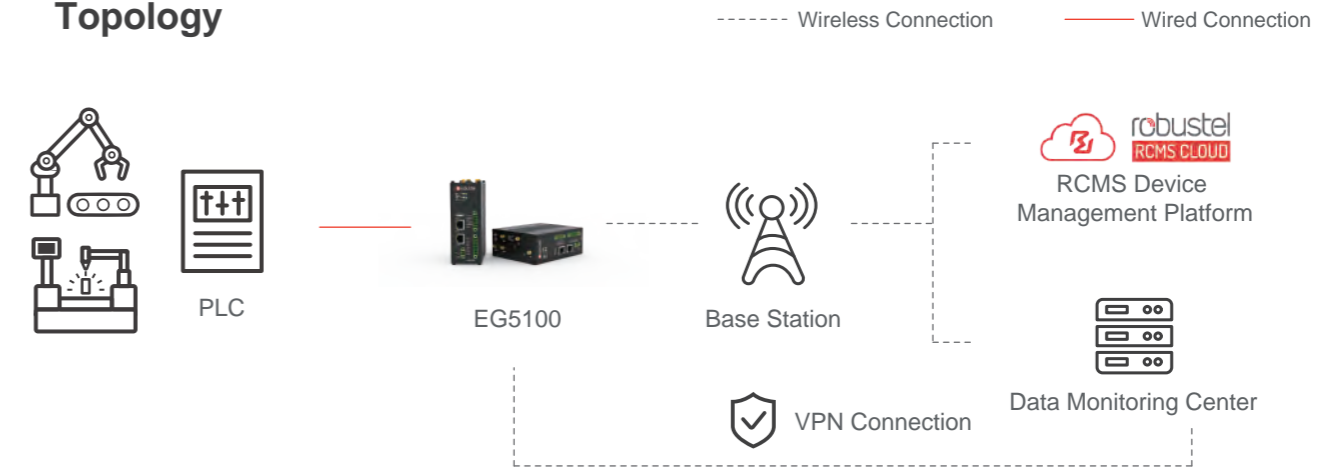

Advantages

- Robust Industrial Design**: Robustel's quality products have industrial housing for reliability in any conditions, and protect against humidity, dust, vibration and EMC.
- Dual SIM Card Design**: Dual SIM backup enhances network resilience - 2 networks are better than 1!
- Serial Ports & Digital IO Onboard**: Support for legacy serial devices with RS232/RS485 interfaces provides maximum flexibility when used as a Modbus RTU interface, with IO for status indication and control.
- Cost-effective Hardware**: Robustel hardware: Industrial grade, durable, wide voltage/temperature range, cost-effective for high volume Industrial/IoT rollouts.

Recommended Product



EG5100



Oil, Gas & Mining

Employing remote control and management to improve safety and efficiency around the extraction of primary resources.

Urban Natural Gas Pipeline Remote Monitoring Solution

Demands & Pain Points

- The gas pipeline is essential infrastructure for ensuring the normal production and daily life of urban residents. The gas supply company holds the important responsibility of maintaining its operation. To achieve this, sensor-monitored pipeline pressure, flow rate, and valve status must be reported to the operation center in real-time, demanding a stable and reliable network connection.
- Natural gas pipeline facilities are geographically spread out with multiple monitoring nodes. Wired network communication is laborious, expensive, time-consuming, and hard to maintain. Hence, the preferred solution is wireless cellular communication.

Solution

Robustel IIoT Gateway obtains data from natural gas pipeline monitoring equipment such as pressure sensors, flow sensors and PLCs via serial ports, and reports status data and alarm information to the operation center of the gas supply company through 4G LTE network in real time, providing intelligent decision-making data basis for natural gas resources scheduling and pipeline maintenance.

Stable Connection

Robustel IIoT Gateway provides cellular network wireless networking, uninterrupted data transmission for various networking scenarios.

Security and Reliability

Nettitude, a well-known global cybersecurity lab, tested and approved RobustOS as a gateway operating system for IoT applications.

Remote Operation and Maintenance

Robustel's RCMS device management platform provides remote, real-time monitoring and diagnosis, allowing maintenance staff to work off-site.

Topology

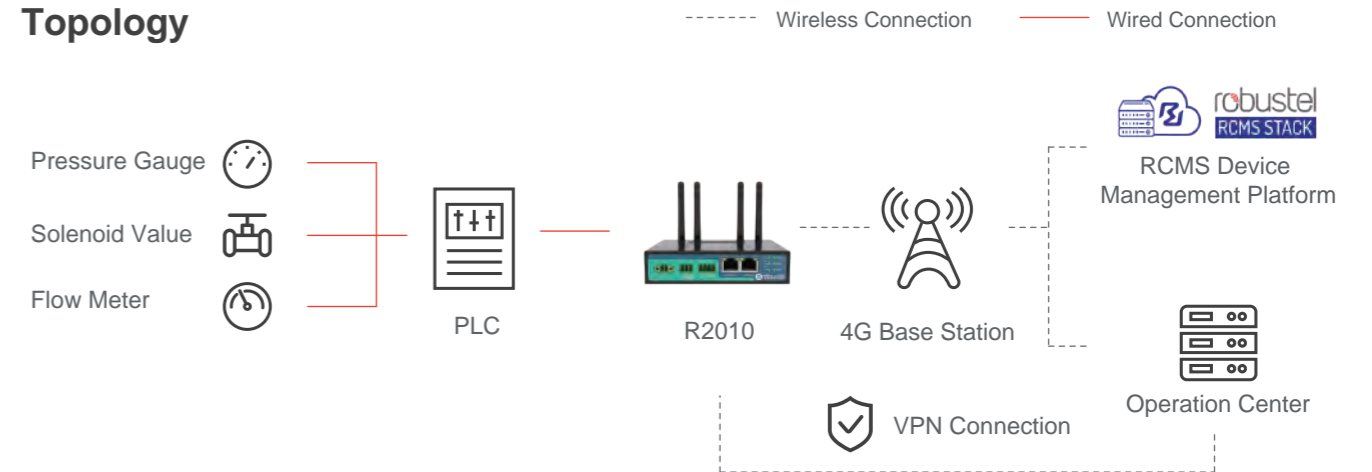

Advantages



Robust Industrial Design

Robustel's quality products have industrial housing for reliability in any conditions, and protect against humidity, dust, vibration and EMC.



Dual SIM Card Design

Dual SIM backup enhances network resilience - 2 networks are better than 1!



Serial Ports & Digital IO Onboard

Support for legacy serial devices with RS232/RS485 interfaces provides maximum flexibility when used as a Modbus RTU interface, with IO for status indication and control.



Customer-hosted Router Management Platform

RCMS router management platform can create a private "walled garden" when installed on customer's data center or cloud infrastructure for excellent router management.

Recommended Product



R2010



Enterprise IT

Primary internet access or fixed line failover connectivity for distributed office, retail or branch environments.

Enterprise Branch Disaster Recovery 5G Networking Solution

Demands & Pain Points

- Communication failures can cripple enterprise networks, jeopardizing their reliability. To mitigate service disruptions and ensure operational continuity, many businesses are seeking solutions.
- Quick network restoration is crucial to minimizing disruptions and resuming normal business functions efficiently.

Solution

Enterprise office devices can be connected to the core switch via Ethernet/Wi-Fi. The gateway is connected to the enterprise's main switch through an Ethernet port as the primary network and uses cellular networks as a backup. The cellular network, combined with VPN tunnels, creates a secure virtual LAN between enterprise branch offices. This ensures a secure and stable backup network connection, even in the event of a main network failure.

Intelligent Switching

RobustOS link management function detects network connections in real time and quickly switches to another backup network link, reducing network connection interruption time.

Security and Reliability

Nettitude, a well-known global cybersecurity lab, tested and approved RobustOS as a gateway operating system for IoT applications.

Information Encryption

RobustOS securely establishes VPN encrypted tunnels with the data center through comprehensive security policies, ensuring the security of information transmission.

Topology

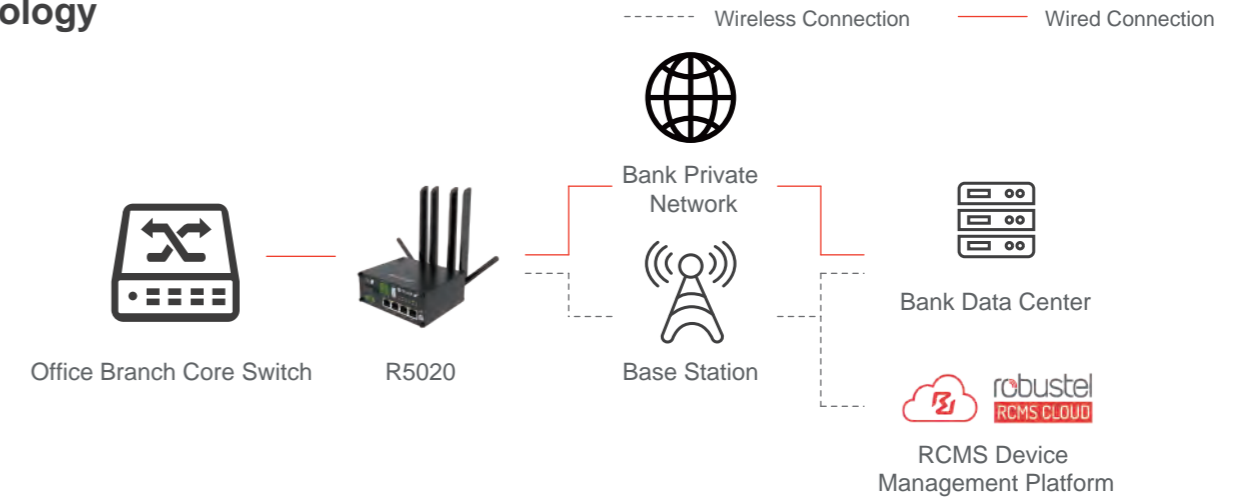

Advantages



Free Router Management Platform

RCMS router management platform manages SIMs and routers at scale. Free basic version, advanced features on PAYG - compelling commercially.



Cellular Connection Keepalive

Robustel's cellular keepalive monitors and recovers from connectivity loss between routers and mobile networks.



Dual SIM Card Design

Dual SIM backup enhances network resilience - 2 networks are better than 1!



Cost-effective Hardware

Robustel hardware: Industrial grade, durable, wide voltage/temperature range, cost-effective for high volume Industrial/IoT rollouts.

Recommended Product



R5020

Bank Branch 5G Connectivity Solution

Demands & Pain Points

- A customer-focused bank places great emphasis on ensuring consistent customer service, as even a momentary network disruption can lead to dissatisfaction and harm the bank's operations.
- With financial safety a top priority, banking institutions must implement robust network security measures to safeguard customer transactions and data. This is vital in mitigating risks and minimizing potential financial losses.

Solution

The networked devices of bank branch are connected to the core switch through wired or Wi-Fi connections. The router is connected to the bank's core switch through an Ethernet port as the primary network, while also utilizing cellular networks as a backup network. The combination of cellular networks and VPN tunnels creates secure virtual LAN between bank branches, ensuring a safe and stable backup connection even in the event of primary network failures.

Stable Connection

Robustel IIoT Gateway provides cellular network wireless networking, uninterrupted data transmission for various networking scenarios.

Security and Reliability

Nettitude, a well-known global cybersecurity lab, tested and approved RobustOS as a gateway operating system for IoT applications.

Information Encryption

RobustOS securely establishes VPN encrypted tunnels with the data center through comprehensive security policies, ensuring the security of information transmission.

Topology

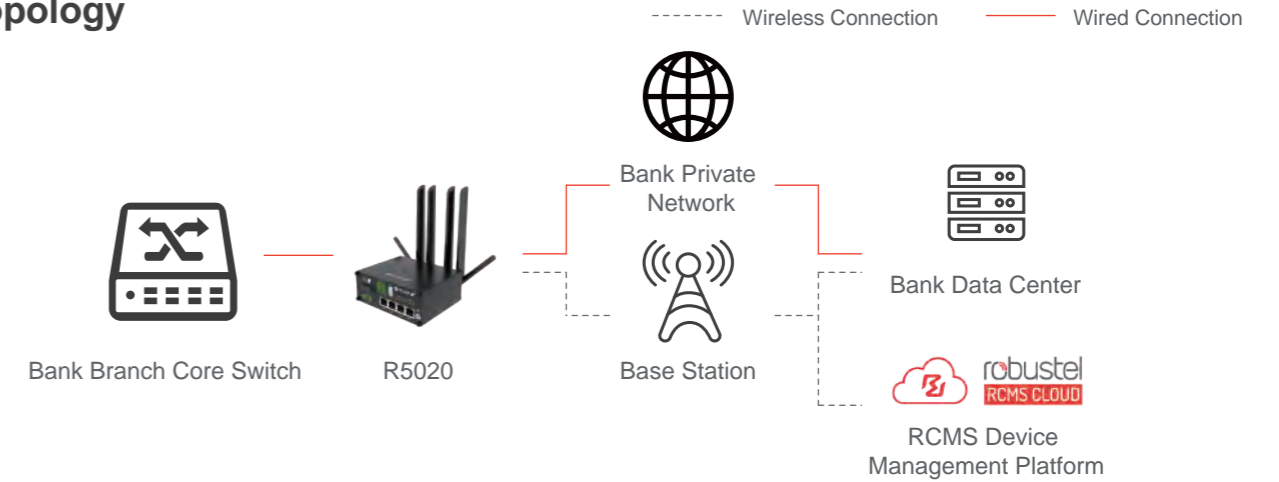

Advantages



Cost-effective Hardware

Robustel hardware: Industrial grade, durable, wide voltage/temperature range, cost-effective for high volume Industrial/IoT rollouts.



Cellular Connection Keepalive

Robustel's cellular keepalive monitors and recovers from connectivity loss between routers and mobile networks.



Dual SIM Card Design

Dual SIM backup enhances network resilience - 2 networks are better than 1!



Free Router Management Platform

RCMS router management platform manages SIMs and routers at scale. Free basic version, advanced features on PAYG - compelling commercially.

Recommended Product



R5020



Retail & Payments

Wireless Monitoring and Communications for ATMs, Vending Machines, Kiosks, Digital Signage and Point of Sale systems.

Bank ATM Machine Networking Solution

Demand & Pain Points

- ATM machines are widely used, even in remote areas where wired networks are unavailable. Secure and reliable wireless connections are the best networking option for ATM machines in such locations.
- ATM equipment in some areas is outdated, and the existing network connectivity doesn't meet current data rate and security norms. Updating the hardware can be costly, so banks need a cost-effective and secure wireless solution with high-speed connectivity.

Solution

The ATM machine is connected to the Robustel IIoT Gateway through a network cable, while the router is connected to the Internet through 4G LTE network, and establishes a secure data transmission tunnel through VPN with the bank's central system, forming a virtual LAN. The ATM machine is able to communicate securely with the bank's central system server.

Stable Connection

Robustel IIoT Gateway provides cellular network wireless networking, uninterrupted data transmission for various networking scenarios.

Security and Reliability

Nettitude, a well-known global cybersecurity lab, tested and approved RobustOS as a gateway operating system for IoT applications.

Information Encryption

RobustOS securely establishes VPN encrypted tunnels with the data center through comprehensive security policies, ensuring the security of information transmission.

Topology

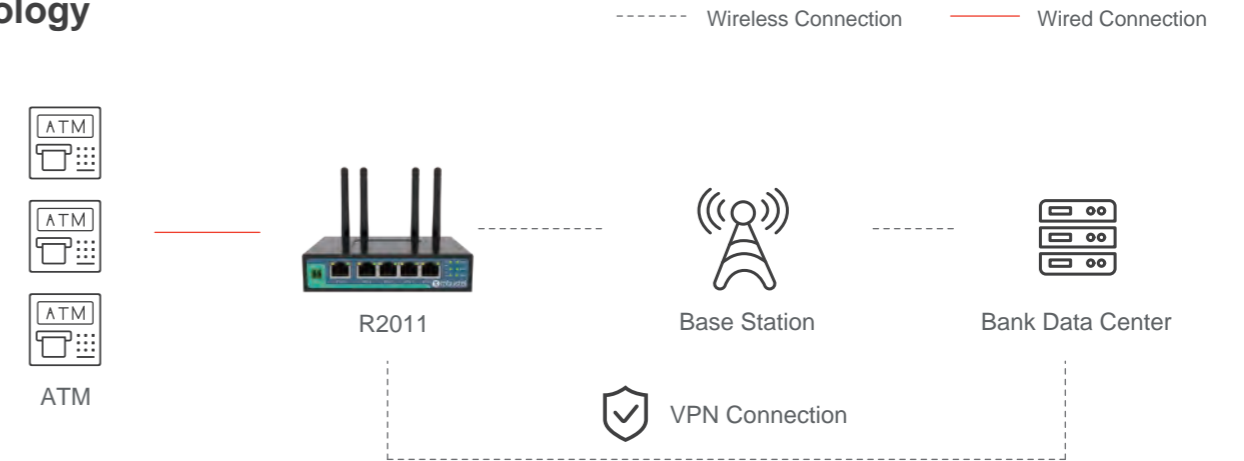

Advantages



Cost-effective Hardware

Robustel hardware: Industrial grade, durable, wide voltage/temperature range, cost-effective for high volume Industrial/IoT rollouts.



Multiple Ethernet ports

Equipped with multiple Ethernet ports. Built-in network switch to meet the needs of multi-device access.



Dual SIM Card Design

Dual SIM backup enhances network resilience - 2 networks are better than 1!



Cellular Connection Keepalive

Robustel's cellular keepalive monitors and recovers from connectivity loss between routers and mobile networks.

Recommended Product



R2011

Self-service Coffee Machine Networking Solution

Demands & Pain Points

- With the rise of smart retail, self-service coffee machines are gaining popularity in cities. However, reliable network connections are crucial to ensure the consistent functionality of these machines. The network connection must remain stable and secure to keep track of inventory and transmit sensitive customer payment information.
- In the event of mechanical failures, quick repairs are necessary to prevent extended downtime. To ensure this, maintenance personnel need to receive timely and accurate notifications of the fault.
- Thus, providing fault monitoring and prompt maintenance services are essential, especially with the deployment of multiple self-service coffee machines in different locations.

Solution

The self-service coffee machine is connected to the Ethernet port of the Robustel IIoT Gateway via a network cable. The gateway establishes a data transmission channel between the vending machine and the RCMS platform through 4G LTE cellular network, and an encrypted transmission channel for the self-service coffee machine and payment platform through routing policies, VPN and other functions, to ensure the safe and reliable operation of self-service retail businesses.

Stable Connection Robustel IIoT Gateway provides cellular network wireless networking, uninterrupted data transmission for various networking scenarios.

Information Encryption RobustOS securely establishes VPN encrypted tunnels with the data center through comprehensive security policies, ensuring the security of information transmission.

Remote Operation and Maintenance Robustel's RCMS device management platform provides remote, real-time monitoring and diagnosis, allowing maintenance staff to work off-site.

Topology

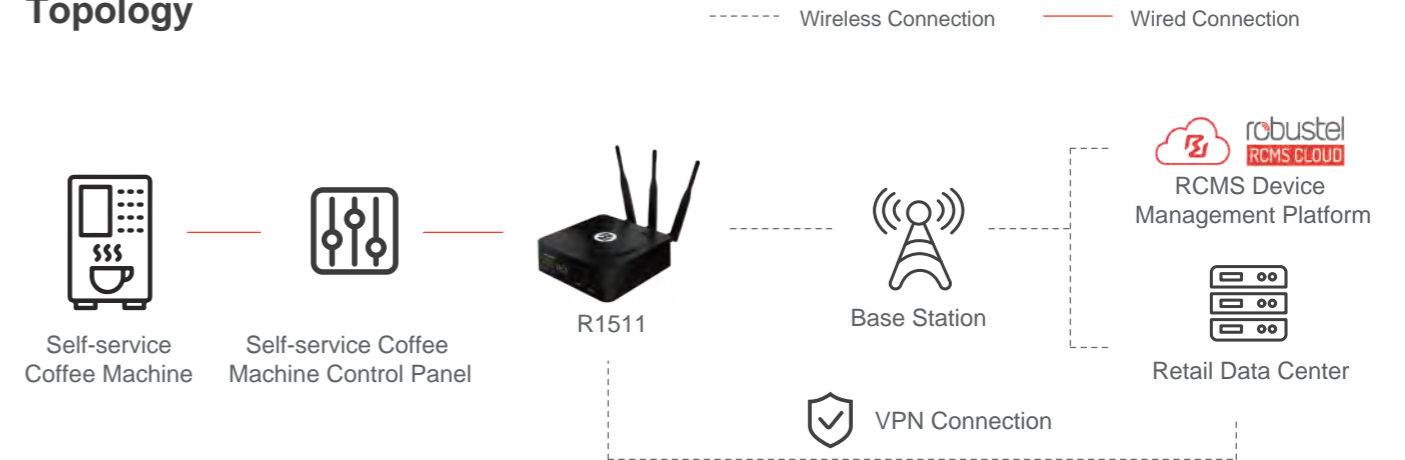

Advantages

- Cost-effective Hardware** Robustel hardware: Industrial grade, durable, wide voltage/temperature range, cost-effective for high volume Industrial/IoT rollouts.
- Flexible 802.11 Wi-Fi Services** Robustel routers offer Wi-Fi client, AP and dual modes, with advanced onboard firewall.
- Serial Ports Onboard** RS232/485 support for Modbus RTU interface, connecting thousands of sensors/instruments for maximum flexibility.
- Free Router Management Platform** RCMS router management platform manages SIMs and routers at scale. Free basic version, advanced features on PAYG - compelling commercially.

Recommended Product



R1511

Digital Signage Networking Solutions

Demands & Pain Points

- Wired networks and manual device replacement are costly for media advertising operators.
- Remote fault diagnosis of scattered digital signages in urban areas is challenging.
- Remote equipment control is necessary to save energy and extend the lifespan of digital signages.
- Reliable connectivity is crucial for frequent content management and optimal advertising effectiveness.

Solution

The digital signages are connected to the Robustel IIoT Gateway through Ethernet cables. The router establishes a connection between the digital signages and the data center via the 5G cellular network, and the data center pushes advertisements to the digital signages as needed. The RCMS device management platform allows for remote management of the digital signages.

High-speed Connectivity

Offers flexible connectivity including 5G/4G/3G cellular networks, Wi-Fi, wired connections and link management function to ensure reliable, high-speed data transmission.

Security and Reliability

Nettitude, a well-known global cybersecurity lab, tested and approved RobustOS as a gateway operating system for IoT applications.

Remote Operation and Maintenance

Robustel's RCMS device management platform provides remote, real-time monitoring and diagnosis, allowing maintenance staff to work off-site.

Topology

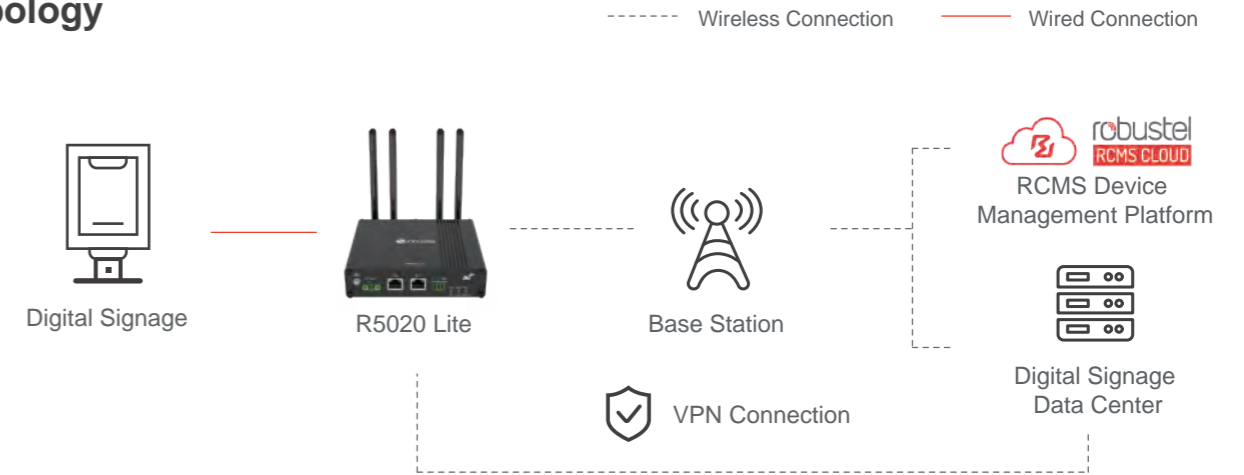

Advantages



Cost-effective Hardware

Robustel hardware: Industrial grade, durable, wide voltage/temperature range, cost-effective for high volume Industrial/IoT rollouts.



Compact Design

Small in size and rich in functions, it can meet the installation requirements in narrow spaces.



Dual SIM Card Design

Dual SIM backup enhances network resilience - 2 networks are better than 1!



Free Router Management Platform

RCMS router management platform manages SIMs and routers at scale. Free basic version, advanced features on PAYG - compelling commercially.

Recommended Product



R5020 Lite

Self-service Parcel Locker Networking Solution

Demands & Pain Points

- Need for reliable internet connectivity in self-service parcel locker that are often located outdoors and in remote locations.
- Some Parcel Lockers are located in remote area, sometimes where the WiFi connection is occasionally unstable.
- Safety and security of the terminals requires constant remote monitoring and management.

Solution

The parcel lockers are connected to the Robustel IIoT Gateway through Ethernet cables. The gateway establishes a connection between the parcel lockers and the data center via the 4G LTE cellular network, with Ethernet ports allowing additional devices to be connected, such as CCTV cameras for security monitoring. The RCMS device management platform allows for remote management of the parcel lockers.

Stable Connection

Robustel IIoT Gateway provides cellular network wireless networking, uninterrupted data transmission for various networking scenarios.

High Reliability

The device has passed rigorous tests to ensure it can withstand harsh environmental impacts and ensure stable data transmission.

Remote Operation and Maintenance

Robustel's RCMS device management platform provides remote, real-time monitoring and diagnosis, allowing maintenance staff to work off-site.

Topology

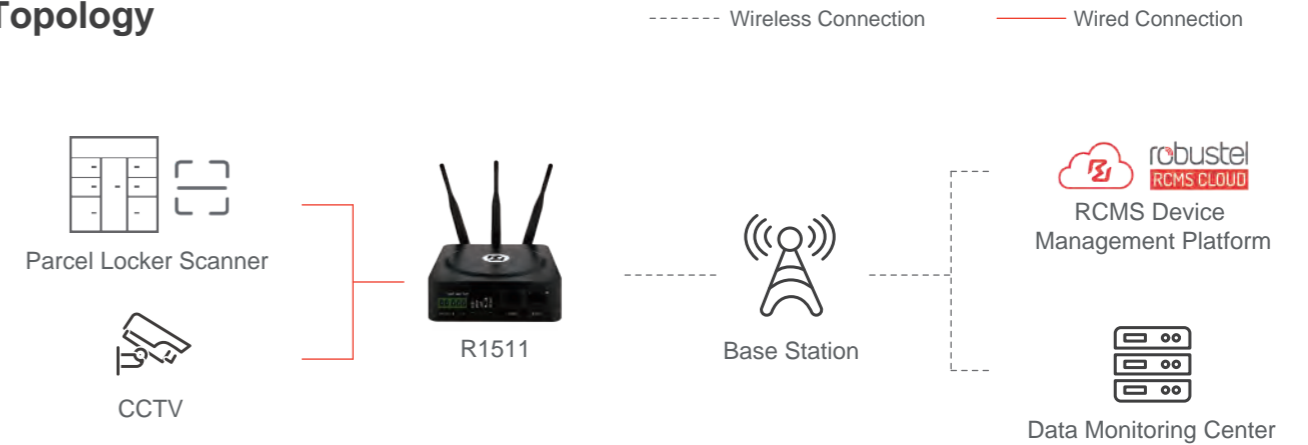

Advantages



Robust Industrial Design

Robustel's quality products have industrial housing for reliability in any conditions, and protect against humidity, dust, vibration and EMC.



Serial Ports Onboard

RS232/485 support for Modbus RTU interface, provides a large space for expansion, and can support and integrate other devices through the RobustOS APP.



Cost-effective Hardware

Robustel hardware: Industrial grade, durable, wide voltage/temperature range, cost-effective for high volume Industrial/IoT rollouts.



Free Router Management Platform

RCMS router management platform manages SIMs and routers at scale. Free basic version, advanced features on PAYG - compelling commercially.

Recommended Product



R1511



Agriculture

Using sensing & wireless technology to improve irrigation, fertilization, yield and more in agriculture and farming.

Farmland Water-saving Irrigation Solution

Demands & Pain Points

- Agriculture informatization has boosted high-quality development. To manage land irrigation accurately, reduce waste, and improve agricultural efficiency, farmers are adopting intelligent irrigation solutions.
- Traditional irrigation methods can waste water resources, requiring significant resources to meet demands. By using data collected by RTUs, an intelligent system of flexible electromagnetic valve adjustments can improve irrigation efficiency, reducing overall water consumption.

Solution

The Robustel IIoT Gateway is connected to the electromagnetic valve through DI/DO interfaces and connected to the remote data acquisition terminals (RTUs) through RS-485. The gateway can achieve intelligent control of electromagnetic valves through event alerts, and establish a connection with the RCMS device management platform via 4G LTE wireless cellular network. The platform can receive alerts in real time, allowing farmers to understand the irrigation situation in the field without the need to be on site.

Stable Connection

Robustel IIoT Gateway provides cellular network wireless networking, uninterrupted data transmission for various networking scenarios.

High Reliability

The device has passed rigorous tests to ensure it can withstand harsh environmental impacts and ensure stable data transmission.

Information Transparency

Through the RCMS device management platform, managers can easily access the location of the devices, their current configuration information, and real-time comprehensive on-site information.

Topology

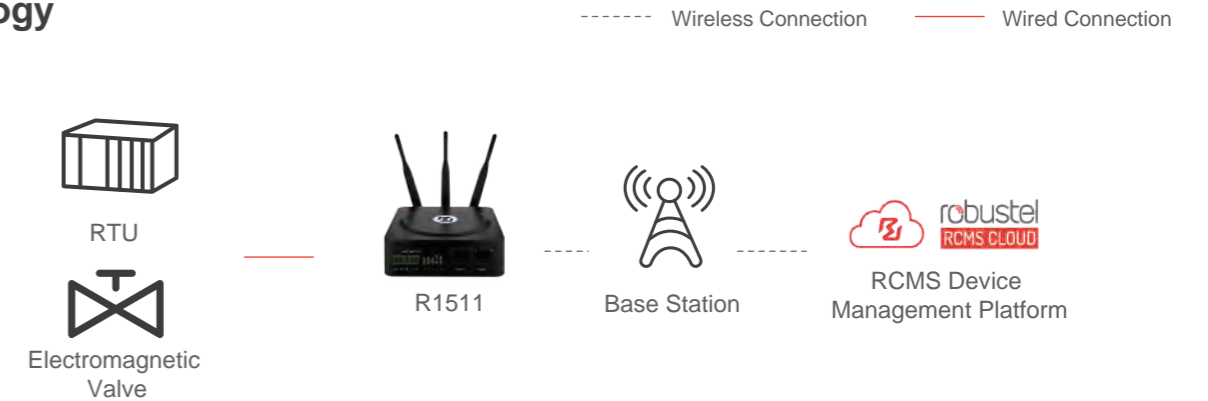

Advantages



Cost-effective Hardware

Robustel hardware: Industrial grade, durable, wide voltage/temperature range, cost-effective for high volume Industrial/IoT rollouts.



Cellular Connection Keepalive

Robustel's cellular keepalive monitors and recovers from connectivity loss between routers and mobile networks.



Digital IO Onboard

Robustel routers: DI - status indication, DO - control/reboot external devices.



Unique (E2C) Edge2Cloud Software

Support for powerful Edge2Cloud IoT Gateway via innovative software, used in many Modbus to Cloud projects.

Recommended Product



R1511

Agricultural Greenhouse Monitoring System Solution

Demands & Pain Points

- High humidity in the planting environment can damage equipment, making it crucial to find an industrial gateway that remains stable even in harsh conditions.
- To create an ideal environment for crop growth, production staff must manage cultivation based on real-time indicators such as temperature, humidity, carbon dioxide concentration, and illuminance. As a result, there is an urgent need to implement greenhouse informatization and intelligent management.

Solution

The Robustel IIoT Gateway is connected to remote data acquisition terminals (RTUs) via RS-485, and the gateway collects RTU data in real time, while reporting data to the RCMS device management platform via 4G LTE wireless cellular network, achieving informationization and intelligent remote management of greenhouses.

Stable Connection

Robustel IIoT Gateway provides cellular network wireless networking, uninterrupted data transmission for various networking scenarios.

High Reliability

The device has passed rigorous tests to ensure it can withstand harsh environmental impacts and ensure stable data transmission.

Topology

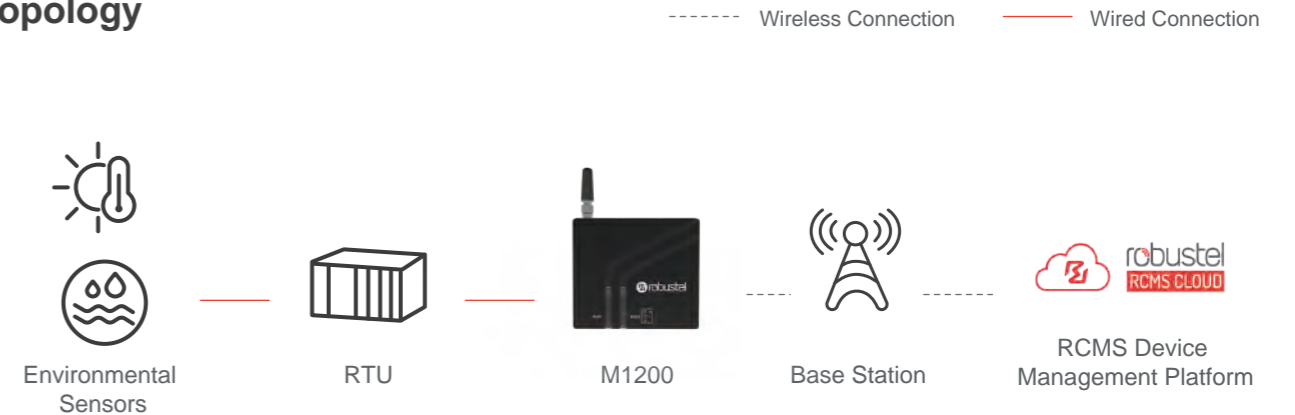

Advantages

- Cellular Connection Keepalive**

Robustel's cellular keepalive monitors and recovers from connectivity loss between routers and mobile networks.
- Cost-effective Hardware**

Robustel hardware: Industrial grade, durable, wide voltage/temperature range, cost-effective for high volume Industrial/IoT rollouts.
- Serial Ports Onboard**

RS232/485 support for Modbus RTU interface, connecting thousands of sensors/instruments for maximum flexibility.
- Free Router Management Platform**

RCMS router management platform manages SIMs and routers at scale. Free basic version, advanced features on PAYG - compelling commercially.

Recommended Product



M1200

Smart Farm Network Connection Solution

Demands & Pain Points

- Smart Farms rely on advanced technology, such as climate control systems and cloud-based crop management software, for efficient and precise crop planting.
- Since farms are often located in remote areas, fixed network resources cannot cover them. Therefore, the farm needs to solve the network connection problem to ensure the reliability of the technology application.
- Without a stable internet connection, advanced technology on the farm becomes unreliable, affecting the quality and safety of food production. Therefore, the program needs to address this food security pain point.

Solution

Sensors, cameras, and other smart devices collect data at various locations on the farm and send it to a centralized data center for processing and analysis. However, farms are often located in remote areas, lacking stable fixed network resources. To solve this problem, we can use Robustel R2010 to provide a stable 4G LTE network connection, and connect to the switch through an Ethernet cable to ensure reliable data transmission and connection stability.

Stable Connection

RobustOS ensures network stability and continuity by automatically switching to backup connections in case of problems, preventing information interruption and farm system malfunction.

Preventive Maintenance Mechanism

Smart farm systems use MQTT protocol for monitoring and data analysis, enabling timely problem detection and preventive maintenance to prevent equipment breakdowns and production interruptions.

Reliable Cloud Service

RCMS enables farm managers to monitor and manage operations remotely using smartphones, tablets, or computers, ensuring smooth farm operations and efficiency.

Topology

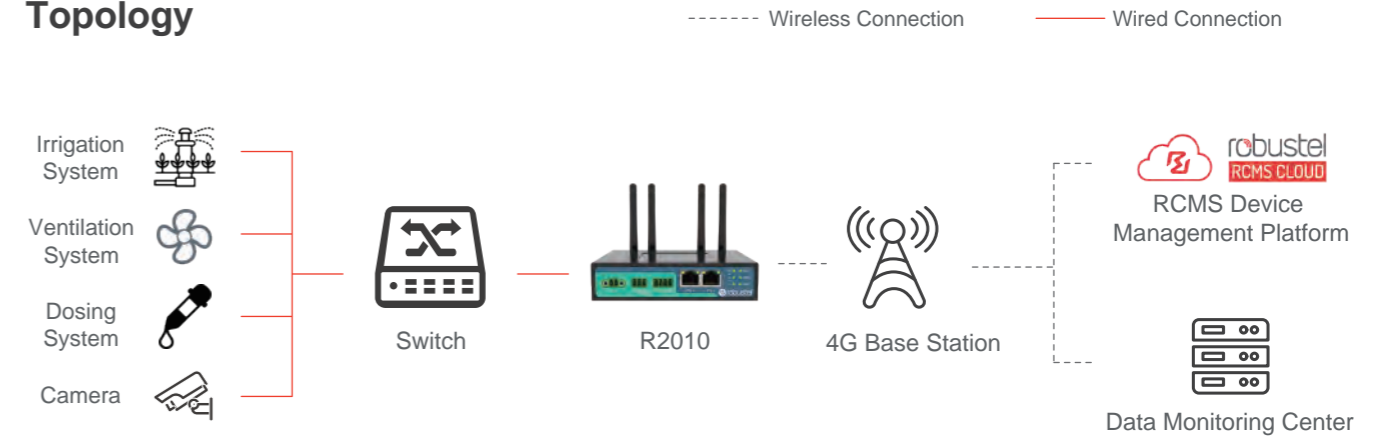

Advantages



Dual SIM Card Design

Dual SIM backup enhances network resilience - 2 networks are better than 1!



Serial Ports Onboard

RS232/485 support for Modbus RTU interface, provides a large space for expansion, and can support and integrate other devices through the RobustOS APP.



Cost-effective Hardware

Robustel hardware: Industrial grade, durable, wide voltage/temperature range, cost-effective for high volume Industrial/IoT rollouts.



Free Router Management Platform

RCMS router management platform manages SIMs and routers at scale. Free basic version, advanced features on PAYG - compelling commercially.

Recommended Product



R2010



Environmental IoT

Environmental IoT solutions for local conditions to realize intelligent environmental monitoring, disaster prevention and environmental compliance.

Waste Water Treatment Solution

Demands & Pain Points

- In the past, remote monitoring and control required costly fiber optic cable installation and network construction. Nowadays, cellular network connectivity has become the more efficient and cost-effective solution.
- When the optical fiber network was accidentally cut, the infiltration well sensors and controllers lost connection with the sewage treatment station due to a lack of backup network. A reliable backup network deployment is thus essential.

Solution

Sensors and solenoid valves are connected to the PLC, which is then connected to the Robustel IIoT Gateway through RS-232/485. The gateway is connected to the RCMS device management platform through cellular wireless network, and the platform seamlessly interfaces with the customer's operation platform for data exchange. Operations personnel can remotely control the operation of the terminal through the RCMS device management platform.

Stable Connection

Robustel IIoT Gateway provides cellular network wireless networking, uninterrupted data transmission for various networking scenarios.

Real-time Collection

RobustOS can run Edge2Cloud applications to collect and upload terminal data, allowing administrators to access real-time on-site data through the cloud platform.

Remote Device Management

RCMS device management platform provides fast real-time monitoring, remote diagnosis, enabling equipment maintenance work to be completed without visiting the site.

Topology

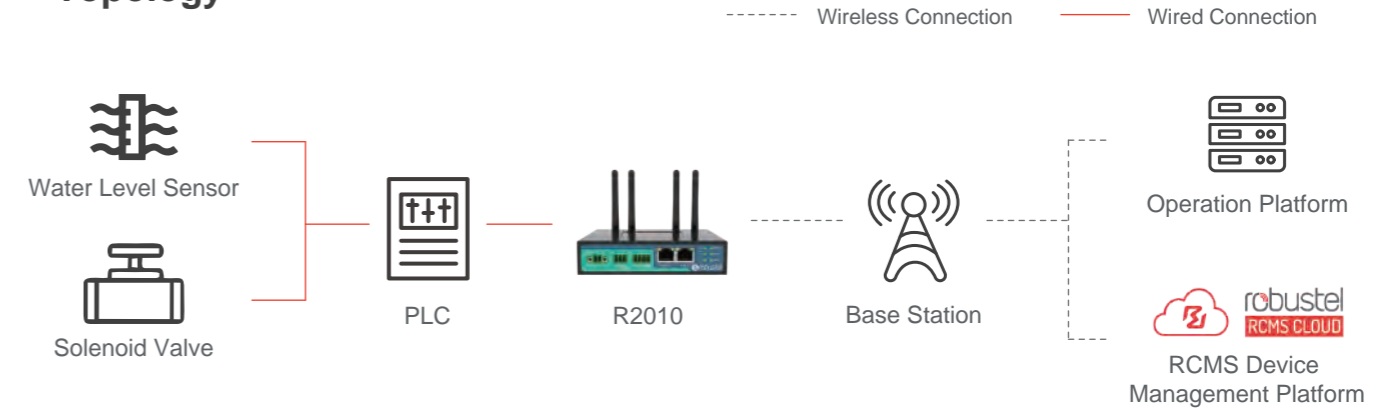

Advantages



Cost-effective Hardware

Robustel hardware: Industrial grade, durable, wide voltage/temperature range, cost-effective for high volume Industrial/IoT rollouts.



Dual SIM Card Design

Dual SIM backup enhances network resilience - 2 networks are better than 1!



Serial Ports & Digital IO Onboard

Support for legacy serial devices with RS232/RS485 interfaces provides maximum flexibility when used as a Modbus RTU interface, with IO for status indication and control.



Extensive International Certifications

Robustel heavily invests in global certifications for Robustel's Global IoT Router, making it one of the most certified worldwide.

Recommended Product



R2010

Hydrometeorological Station Remote Monitoring System Solution

Demands & Pain Points

- Hydro-meteorological monitoring stations can be placed flexibly and aren't limited by environment, but they need industrial-grade networking devices for reliable on-site equipment.
- Accurate weather forecasting requires timely, comprehensive, and refined data, for which reliable data-collecting Industrial IoT gateways are optimal.

Solution

The data collectors and cameras are connected to the Robustel IIoT Gateway, which transmits data to the RCMS device management platform through cellular networks. The platform establishes a seamless connection with the meteorological monitoring center, where data is collected and analyzed to provide further data security for meteorological forecasting work.

High-speed Connectivity Offers flexible connectivity including 4G/3G cellular networks, Wi-Fi, wired connections and link management function to ensure reliable, high-speed data transmission.

Real-time Collection RobustOS can run Edge2Cloud applications to collect and upload terminal data, allowing administrators to access real-time on-site data through the cloud platform.

Integrated Management Robustel's RCMS platform enables simultaneous management of multiple devices, reducing the time spent managing them.

Topology



Advantages

- Robust Industrial Design** Robustel's quality products have industrial housing for reliability in any conditions, and protect against humidity, dust, vibration and EMC.
- High-precision Positioning** Provides precise location via GNSS and accurate navigation.
- Serial Ports & Digital IO Onboard** Support for legacy serial devices with RS232/RS485 interfaces provides maximum flexibility when used as a Modbus RTU interface, with IO for status indication and control.
- Free Router Management Platform** RCMS router management platform manages SIMs and routers at scale. Free basic version, advanced features on PAYG - compelling commercially.

Recommended Product



R2110

Earthquake Monitoring System Solution

Demands & Pain Points

- Seismic observation stations are widely set up in remote suburbs, where fixed network resources are difficult to cover, and the cost of redeploying fixed network dedicated lines is too high. It is necessary to find a network connection method with stable network connection and low cost.
- In order to improve the informatization level of the seismic background field detection system, it is necessary to upload timely and accurate field data to the data center, and it is very important to ensure the stability of the connection.
- Seismic monitoring equipment is a professional equipment, and its data needs to be transmitted through industrial protocols, so it is necessary to find networking equipment compatible with industrial protocols.

Solution

By using Robustel RCMS and R2110 industrial router, the networking solution of the earthquake monitoring system can be realized to ensure the accurate uploading of data and the stability of connection. At the same time, because the cost of Robustel R2110 industrial router is relatively low and it supports multiple protocols, it can be deployed in remote suburbs, reducing deployment and maintenance costs.

Stable Connection

Robustel R2110 industrial router addresses difficult fixed network resource coverage, ensuring stable connections and accurate transmission of earthquake monitoring equipment data.

Low-cost Management Method

Robustel RCMS streamlines network management for seismic observation stations, reducing costs, enabling remote access, fast data upload, and stable connections.

Data Stability and Real-time Performance

Robustel industrial routers and RCMS management platform ensure seismic background field detection system stability, reliability, and preventive maintenance through timely data upload and preventive maintenance mechanisms.

Topology

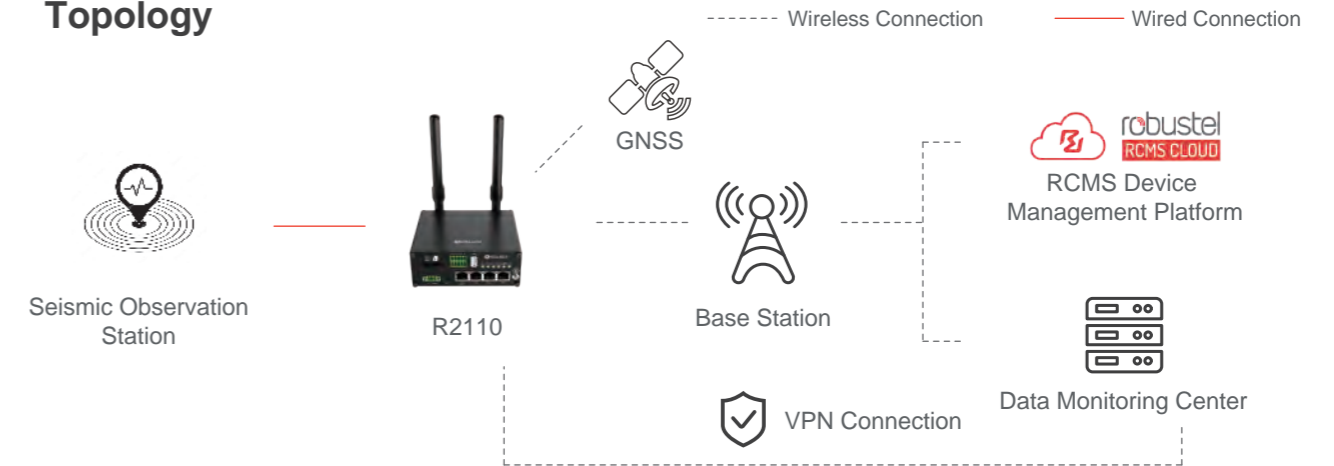

Advantages



Robust Industrial Design

Robustel's quality products have industrial housing for reliability in any conditions, and protect against humidity, dust, vibration and EMC.



Dual SIM Card Design

Dual SIM backup enhances network resilience - 2 networks are better than 1!



Serial Ports & Digital IO Onboard

Support for legacy serial devices with RS232/RS485 interfaces provides maximum flexibility when used as a Modbus RTU interface, with IO for status indication and control.



Multiple Gigabit Ethernet Ports

Equipped with 4x1000M Ethernet ports. Built-in network switch to meet the needs of multi-device access.

Recommended Product



R2110

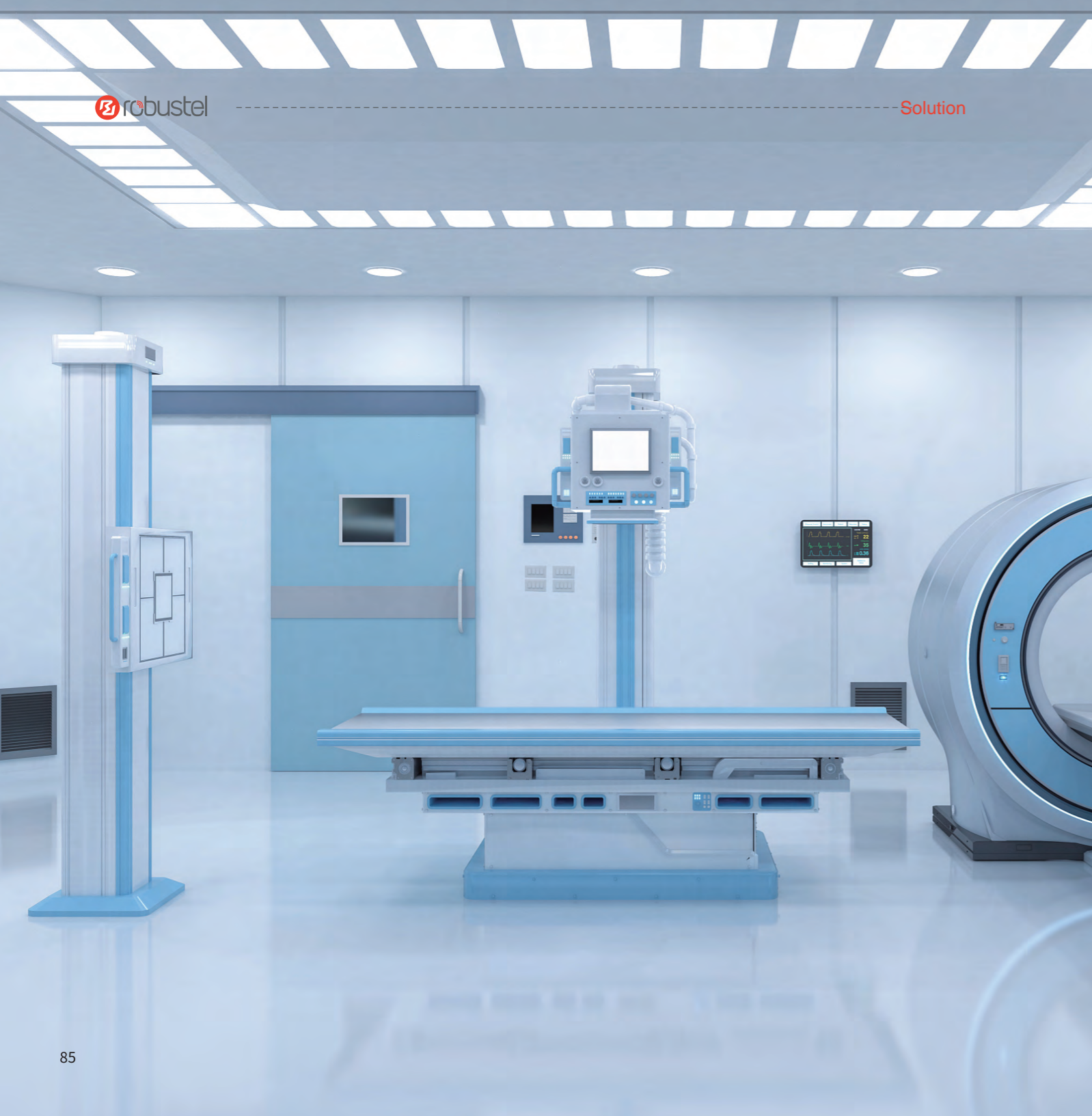

Healthcare

Powering remote diagnostics, telemedicine solutions through wireless communications.

Medical Equipment Maintenance Service Solution

Demands & Pain Points

- Traditional medical equipment maintenance services rely on user feedback and site visits, which can be slow and inefficient.
- Retrieving the status of traditional on-site maintenance work can be delayed, requiring a more efficient data collection and upload solution.
- Mobile and inexperienced operation and maintenance personnel present challenges for equipment maintenance and management, underscoring the importance of an online remote maintenance system.

Solution

The solution deploys the Robustel IIoT Gateway inside the medical equipment. The gateway connects to medical devices through a serial port, and collects the operational data of medical equipment in real time. The gateway uploads the data to the cloud platform via the cellular network, and maintenance personnel can obtain real-time information on the operational status and faults of medical equipment through the cloud platform.

Flexible Configuration

RobustOS offers diversified device management methods, supporting configuration through SMS, Web, CLI, cloud platform, and more even in complex scenarios.

Remote Operation and Maintenance

Robustel's RCMS device management platform provides remote, real-time monitoring and diagnosis, allowing maintenance staff to work off-site.

Integrated Management

Robustel's RCMS platform enables simultaneous management of multiple devices, reducing the time spent managing them.

Topology

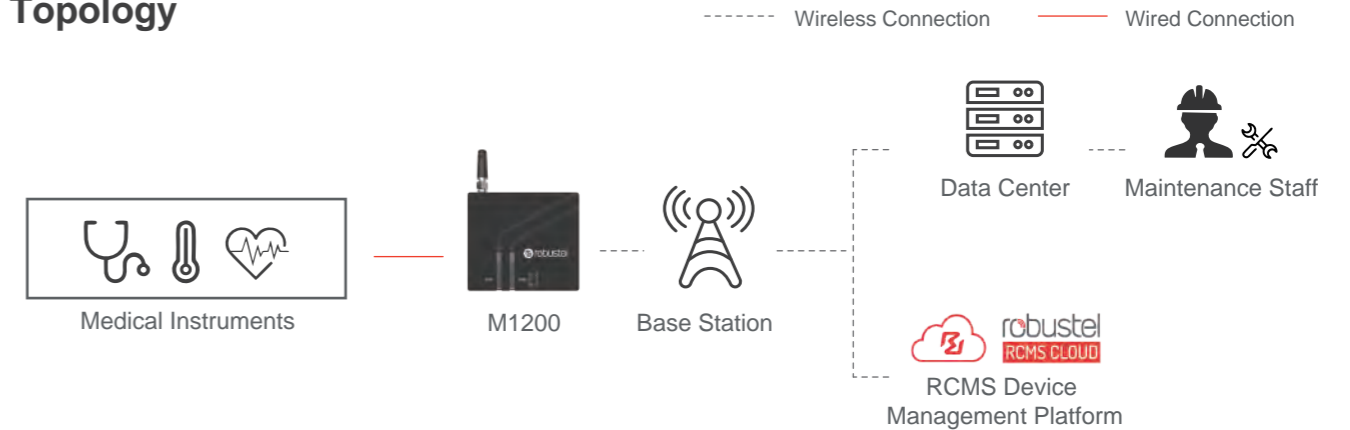

Advantages



Cost-effective Hardware

Robustel hardware: Industrial grade, durable, wide voltage/temperature range, cost-effective for high volume Industrial/IoT rollouts.



Serial Ports Onboard

RS232/485 support for Modbus RTU interface, connecting thousands of sensors/instruments for maximum flexibility.



Connect Directly to IoT Platforms

Seamlessly link with IoT cloud platforms like MS Azure IoT Hub, AWS, Alibaba, Tencent, DeviceWISE & MQTT-based platforms.

Recommended Product



M1200

5G+Ambulance Networking Solution

Demands & Pain Points

- The conventional method of transportation to the emergency department wastes time and may jeopardize patients' chances of survival.
- For effective remote diagnosis, live video streaming at 1080p and 30 FPS is essential, requiring a reliable network connection.
- To safeguard patient privacy, urgent medical information must be securely stored and accessed through information technology. The transmission of data between the hospital and ambulance services must also be secure.

Solution

Medical instruments and on-site monitoring are connected to the Robustel IIoT Gateway via Ethernet, and the gateway transmits data to the medical platform via high-speed cellular networks. Doctors can promptly monitor patients' vital signs and health status through the medical platform, and thus provide timely and effective guidance for remote treatment.

High-speed Connectivity | Offers flexible connectivity including 5G/4G/3G cellular networks, Wi-Fi, wired connections and link management function to ensure reliable, high-speed data transmission.

Security and Reliability | Nettitude, a well-known global cybersecurity lab, tested and approved RobustOS as a gateway operating system for IoT applications.

Integrated Management | Robustel's RCMS platform enables simultaneous management of multiple devices, reducing the time spent managing them.

Topology

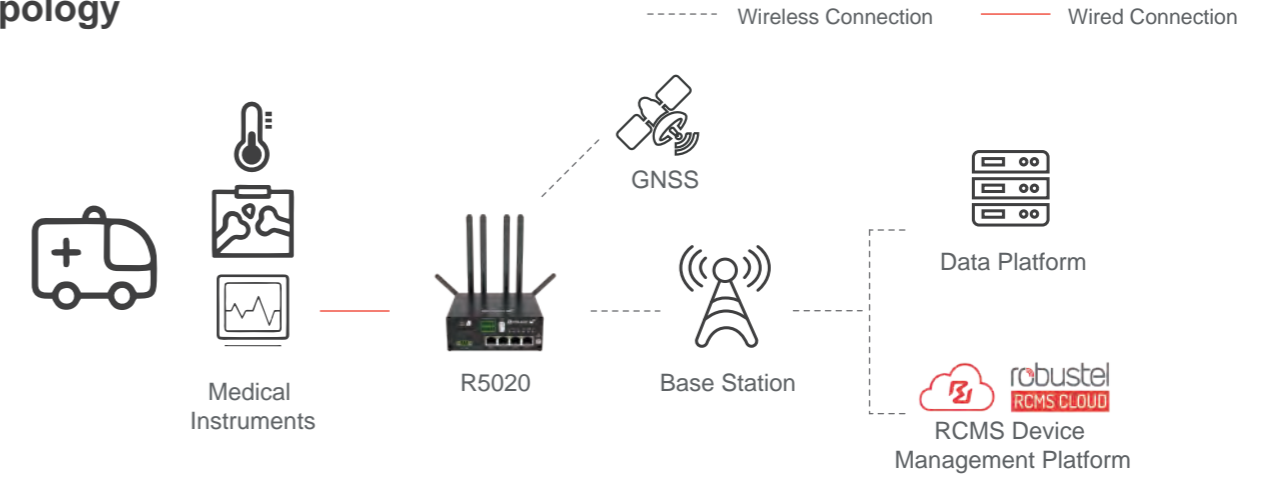

Advantages

- Robust Industrial Design** | Robustel's quality products have industrial housing for reliability in any conditions, and protect against humidity, dust, vibration and EMC.
- Dual SIM Card Design** | Dual SIM backup enhances network resilience - 2 networks are better than 1!
- Flexible 802.11 Wi-Fi Services** | Robustel routers offer Wi-Fi client, AP and dual modes, with advanced onboard firewall.
- Free Router Management Platform** | RCMS router management platform manages SIMs and routers at scale. Free basic version, advanced features on PAYG - compelling commercially.

Recommended Product



R5020

Telemedicine Solution

Demands & Pain Points

- Telemedicine relies on high-bandwidth networks for video consultations.
- Industrial-grade routers are preferred for medical monitoring equipment that uses industrial protocols.
- Uninterrupted network connectivity and a 24/7 early warning reception platform are crucial for providing patients with the best available treatment.

Solution

Video communication devices are connected to the Internet via the 5GHz Wi-Fi network provided by the Robustel IIoT Gateway, while medical monitoring instruments are connected to the gateway via an industrial protocol. The gateway collects data from the medical monitoring instruments and transmits it via the high-speed 5G cellular network to the doctor's office. The doctor can use the visualized data generated by the data platform to gain a detailed understanding of the patient's health indicators.

High-speed Connectivity

Offers flexible connectivity including 5G/4G/3G cellular networks, Wi-Fi, wired connections and link management function to ensure reliable, high-speed data transmission.

Real-time Collection

RobustOS can run Edge2Cloud applications to collect and upload terminal data, allowing administrators to access real-time on-site data through the cloud platform.

Integrated Management

Robustel's RCMS platform enables simultaneous management of multiple devices, reducing the time spent managing them.

Topology

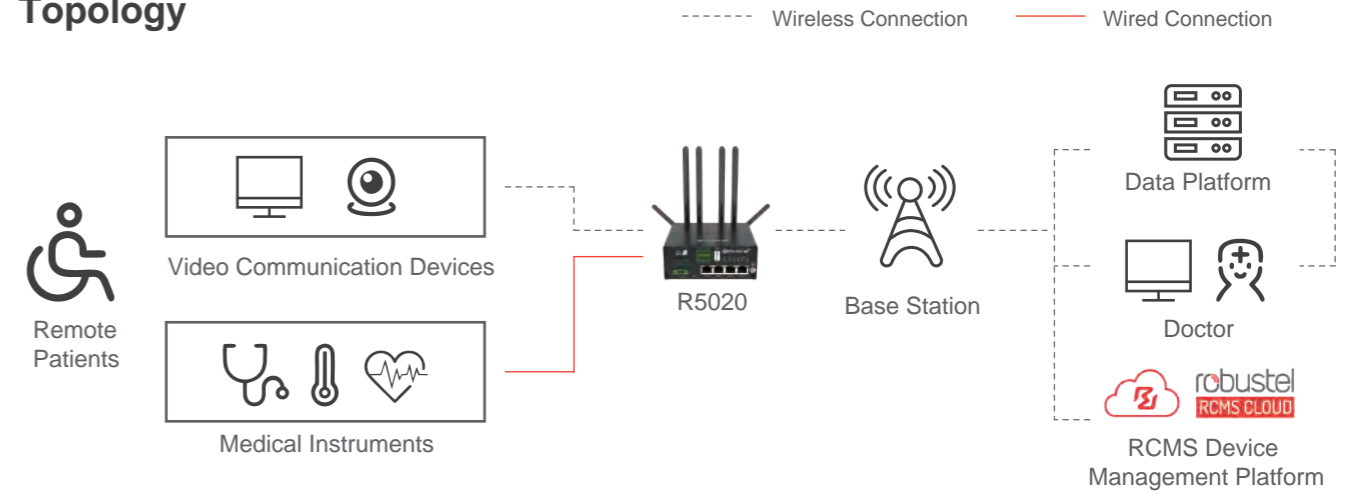

Advantages



Robust Industrial Design

Robustel's quality products have industrial housing for reliability in any conditions, and protect against humidity, dust, vibration and EMC.



Extensive International Certifications

Robustel heavily invests in global certifications for Robustel's Global IoT Router, making it one of the most certified worldwide.



Flexible 802.11 Wi-Fi Services

Robustel routers offer Wi-Fi client, AP and dual modes, with advanced on board firewall.



Free Router Management Platform

RCMS router management platform manages SIMs and routers at scale. Free basic version, advanced features on PAYG - compelling commercially.

Recommended Product



R5020



Case Study

The Robustel Case Studies are a detailed account of how Robustel has worked with local partners and end customers to deliver a specific use-case in market.

CHECKPOINT & ROBUSTEL ROLL OUT COAST-TO-COAST 4G FOR USA RETAILER

A 1000 SITE SUCCESS STORY FROM CHECKPOINT SYSTEMS, INC. & ROBUSTEL



About Checkpoint

Checkpoint Systems, Inc. is one of the only vertically integrated RF/RFID solution providers for retail, delivering software, hardware, labels, tags, service, and connected cloud-based solutions. Checkpoint is a global leader in EAS and radio frequency identification (RF and RFID) technology solutions across a diverse range of markets including apparel, grocery, electronics, DIY, health & beauty, cosmetics, craft, logistics, drug, discount and specialty...

Checkpoint installs on average 30,000 global installations annually, and has 11,000 connected stores worldwide.

In recent years, a desirable addition to the standard EAS proposition is to add remote monitoring to derive customer insight and valuable footfall information. This is then presented in an easy-to-assimilate fashion courtesy of Checkpoint's software.

Adoption of the service can be hampered by non-availability of an internet connection in store (diligent IT Departments often cannot allow 3rd party equipment on their WAN) & this is when an independent, low cost 4G solution becomes essential to realise value from a 'connected store'.

Case Studies

Checkpoint's 'pedestals' have an Ethernet interface that can connect to a 3rd party router such as the Robustel R2000 used in this project.

The R2000 router provides a resilient 4G connection to the internet with a SIM that allows connections to both the AT&T and T-Mobile networks.

With a reliable internet connection in place, 3x cloud-based services can be used as follows:

Checkpoint's Store Operations can monitor the entire estate of EAS pedestals worldwide and provide additional insights from sensors like footfall counters as part of its service.

Checkpoint's Network Operations Center can use a VPN connection to connect in remotely to any store at any time using the R2000 as the gateway to the pedestal and associated equipment.

A recently added addition to the system is a connection to Robustel's router management platform - RCMS. This free service gives unparalleled estate-wide monitoring and ability to perform over the upgrades of all software in the store.

Solution Topology

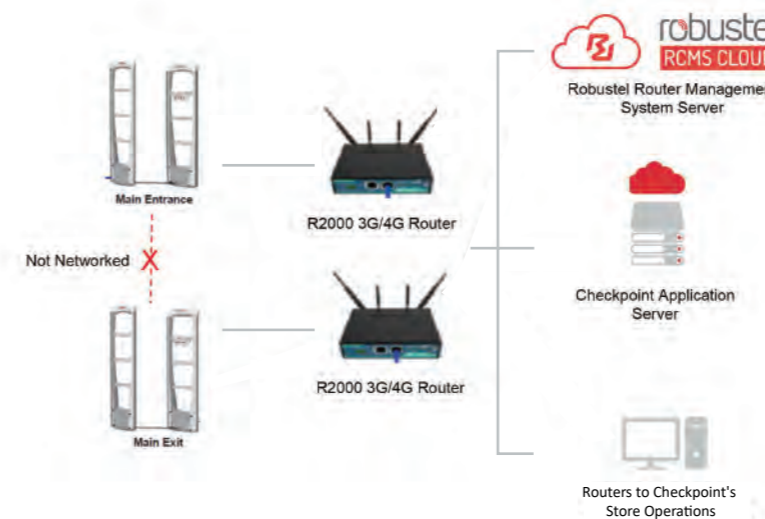

Figure 1.1 - Network topology of remote management solution

ROBUSTEL FEATURED PRODUCT R2000 3G/4G Router



- 3G/4G router with Wi-Fi & Dual SIM capability
- Free Microsoft Azure hosted cloud platform
- Data-Guard v2 application provides enhanced functionality for Roaming SIMs
- Fully programmable with extensive SDK environment

BUSINESS CHALLENGE 1

In-store availability of ‘free’ internet access

One of the biggest challenges of installing ‘internet-connected’ hardware into 3rd party retail outlets is the availability of an internet connection. In fact, it’s often a binary answer from the retail chain IT Dept ‘yes you can’, or, for security reasons - ‘no you cannot piggy back on our corporate network’.

When companies like Checkpoint are confronted with the latter, it can be a tough quandary. Either desist with the ‘internet connected’ piece which is often a big part of the value - prop, or alternatively, install your own solution using 4G.

The 4G solution can seem trivial at the outset but can quickly become a complex Pandora’s with hidden risks related to airtime over usage, reliability, hardware CAPEX, airtime OPEX, system architecture and setting up of the solution for maximum resilience.

In this respect, Robustel offered a turnkey consultancy service, providing end to end consultancy helping Checkpoint and its customer to avoid the many pitfalls.



“ Robustel worked very closely with Checkpoint Systems in the design, integration and even the SIM selection for a robust 4G solution across the USA, sharing their expertise at every turn.

For one particular retailer we rolled out over 1000 Robustel routers and they have delivered flawless performance since being installed, which allowed us to get estate-wide 4G connectivity in place very quickly and very cost-effectively.

Joe Esposito, VP Customer Operations, Checkpoint Systems, Inc.

”

BUSINESS CHALLENGE 2

Reliability of 3G/4G internet access

Checkpoint’s systems are generally located inside retail outlets like supermarkets, drug stores, dollar stores, big-box retailers and apparel stores - a nice environment for humans, but often not such a nice RF environment for cellular devices trying to reach surrounding cell towers. Metal clad buildings can do a good job of attenuating radio waves at a variety of frequencies including those used for 3G/4G communications.

Robustel provided guidance on the choice of a roaming SIM that could connect to both the AT&T and T-Mobile networks in the USA, opting for an ‘unsteered’ roaming SIM that is optimised for best possible chance of a connection - not for the network operator’s commercial benefit as is generally the case with ‘steered’ roaming SIMs. This solution instantly improves overall estate uptime as, quite simply, two radio networks are better than one!

Using a roaming SIM combined with good antenna choice/placement & optimised router configuration helped to deliver a very high uptime across the 1000 router estate allowing Checkpoint to focus on their core competence – delivering an exceptional EAS experience for the retailer.

BUSINESS CHALLENGE 3

Capital cost of 1000 x 4G routers

Due to the number of stores requiring internet connectivity, over 1000 x 4G routers needed to be purchased. At this scale, the absolute cost of each router becomes a key consideration for the feasibility of such a roll-out. Price/Performance ratio is critical in such an application as buying ‘cheap’ can result in a disaster due to poorly written firmware or non-industrial build quality.

Conversely, the cost of an ‘over-engineered’ solution can negatively impact the business case upfront and 3G/4G connectivity - a key enabler of the Internet of Things - can be out of the reach of some projects.

The Robustel R2000 was able to hit a very aggressive price-point to fit the business case as well as providing highly stable long-term communications.

“ Although trivial in principle, connecting a large estate of retail outlets always comes with its challenges. The Checkpoint team invited us to help make sure that all considerations - antenna type and location, router config, network architecture, roaming SIM type + more were well scrutinised prior to deployment. It is testimony to Checkpoint’s diligence & professionalism and Robustel’s high product quality that the 4G solution continues to provide uninterrupted connectivity across the length and breadth of the USA.

David Evans, Global IoT Solution Architect, Robustel

”

COLD-CHAIN MONITORING OF VACCINES IN VEHICLES & BUILDINGS

A success story from Koolzone & Robustel

About Koolzone

KoolZone was founded in 2015 in Germany and now has global headquarters in Henley-on-Thames in the UK, then focusing on monitoring refrigeration temperatures as a disruptor to the manually intensive practices employed by the food sector to meet food safety standards.

However, it soon became apparent that MaaS (Monitoring-as-a-Service) using plug-and-play long-range wireless technology (LoRaWAN) was the key to safety, compliance, and cost reduction across a wide range of industries.

Koolzone's wireless, cloud based monitoring solutions are now installed in 16 locations in 4 continents monitoring in Healthcare, pharma, life sciences, universities, food & drink and supply chain. Most recently, Koolzone has been working with the Jenner Institute, home of the Oxford-AstraZeneca vaccine in both monitoring both the development of the vaccine and also the storage of the Covid-19 virus.

Koolzone specialise in the monitoring of cold storage conditions in both fixed laboratory and hospital locations and vehicle in transit. They monitor temperature in medical-grade Fridges & Freezers, but also -80°C ULT (Ultra Low Temperature) Freezers and Liquid Nitrogen tanks, as well as electrical power supply.

KoolZone currently have over 20 sensors and are able to monitor: pressure, humidity, CO2, power, energy, leaks, events, GPS and temperatures ranging from -200°C to +1,300°C for small businesses and multinational corporations alike.



Solution Overview

At the heart of Koolzone's proposition is the ability to measure extreme temperatures in hard to reach places and this is enabled through Koolzone's industry leading Quantum Sensor, designed by the KoolZone engineers to be an all round reliable sensor. It employs the latest in platinum resistance probes manufactured and compliant to BS EN 60751, so that the indicated temperature is accurate to $\pm 0.4^{\circ}\text{C}$ and can be supplied with a UKAS calibration certificate.

Installation is very simple: just place the sensor in side any controlled environment and it will auto pair with the Robustel LoRaWAN gateway. It has a battery life of 3 to 7 year depending on the sampling period and can measure temperature down to -100°C . It is housed in durable food-safe plastic and can manage both data logging and history retrieval with an extended LoRaWAN rejoining policy.

Gateway

The R3000 LG LoRaWAN Gateway forms a bridge between the local wireless link to sensors in the building and the internet. Reliable operation of this keystone is essential and thanks to Robustel's industrial heritage and highly stable Operating System, the R3000 LG will continue to work unattended for years on end. In case of network issues, self-recovery mechanisms are in place and the entire estate can be monitored through the MS Azure hosted cloud platform - RCMS (Robustel Cloud Manager Service).

Solution Topology

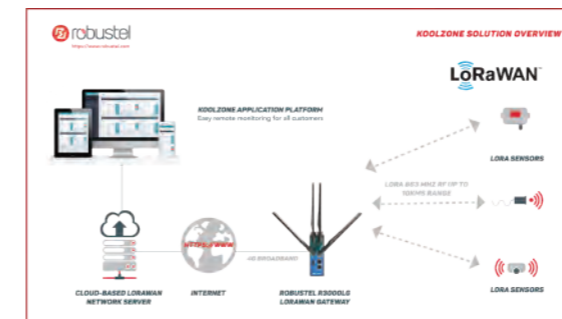

Figure 1.1 – Koolzone's LoRaWAN-based solution architecture

ROBUSTEL FEATURED PRODUCT R3000 LG 4G LoRaWAN Gateway



- 8 channel LoRaWAN interface
- Rugged and durable housing and connectors
- Free cloud management platform
- Smart Roaming for enhanced Roaming SIM management
- Fully programmable OS with an SDK
- Wide operating temperature range

Koolzone Platform

Koolzone offers monitoring-as-a-service, with all the data collected from our sensors in securely in real-time and is accessible in clear and easy to configure reports, accessible via any browser from any device. Real time alerts and reminders can be sent to users by text, phone call, or email which are only triggered when there is a problem and values fall outside of the pre-defined range.

Auto generated, error free and legally compliant reports can be set up to users save time and money and drive compliance.

BUSINESS CHALLENGE 1

Installing Sensors Inside Fridges

Fridges and freezers are faraday cages – which means they block electromagnetic fields, so for instance Wi-Fi or Bluetooth connections will be blocked.

Equally you do not want to want to break the integrity of your freezer by having wires through the seal, attaching the internal sensor to an externally transmitter.

Our Koolzone sensors use powerful long range (LoRaWAN) wireless communications, which easily transmit data through the walls of freezers to the Robustel gateway.

The sensors are placed inside the freezer, typically at the top, to monitor maximum temperature and can either be adhered to the wall or placed in the upper most drawer. Koolzone sensors also have a battery life of 7 years at -80, which results in low servicing costs.



“ The partnership between Koolzone and Robustel means that we are able to reliably and securely monitor the valuable contents of freezers in all environments.

As a result of this, clients who have deployed our solutions have peace of mind 24 hours a day 365 days a year.

We had a – 80 that went down last Saturday morning when no one was on site at a research laboratory, and we were able to quickly recover the contents avoiding all losses.

Steve Miller, Managing Director, Koolzone Ltd ”

BUSINESS CHALLENGE 2

Reliability of 3G/4G Communication

Roaming SIMs are often sold as a way to improve 3G/4G reliability, but whilst the fundamental premise is accurate, standard LoRaWAN Gateways do not always achieve the best results when using roaming SIMs due to suboptimal behaviour of “automatic network selection.” In short, you can pay extra for the resilience of a multi-network SIM and still find that there are comms outages. Smart roaming is a standard feature of the Robustel gateways employed by KoolZone. They achieve an excellent overall estate uptime on 3G/4G connections anywhere in the world.



“ We have all learned a lot about the deployment of LoRaWAN solutions into commercially sensitive and time-critical monitoring applications in the cold-chain market. This means both Robustel & Koolzone are well equipped to help customers in cold-chain and other markets looking to employ this exciting new wireless technology.

Working with Koolzone has been a pleasure as there is always a desire to employ smart technology & innovation to remove any obstacles in the path to success.

David Evans, IoT Solution Architect, Robustel ”



The launch of the PFM Experience Centre

THE PFM EXPERIENCE CENTRE ON WHEELS

A success story from PFM and Robustel



About PFM

The PFM Intelligence Group is an organisation with various disciplines and a wide variety of clients, all with a focus on People Flow Management, by creating actionable data insights that translate into improvements in business performance.

PFM works directly with clients across a range of sectors by offering a highly experienced team to design, procure and manage the implementation of ICT, Audio Visual and Intelligent Building technology. Throughout the years PFM added offices in several countries and collaborated with partners in order to expand our business globally.

After acquiring CoreTech Solutions, the market leading IT infrastructure provider of the UK retail property sector, PFM became a significant player in integrated technology systems, focusing on complex consumer data insights to create business critical market intelligence that helps clients navigate the challenges of the retail and infrastructure sector, by mapping and analyzing visitor flows in shopping centers and shops, among other places. Their technologies have been applied over 35,000 shops, 30 transport hubs, 450 shopping centres and 600 streets, serving many international clients, like Asics, Perry, De Bijenkorf, C&A and Lush.

Background Overview

'Data beats emotion', says Michel l' Amie, IT & innovation manager at PFM . 'You can have the feeling that it [retail store] has been busy, but if the turnover subsequently falls behind, it is useful to know why that is the case.'

To provide better insight into the possibilities of, for example, the use of heat mapping, the mixing and analysis of data and gender identification, the company recently launched the PFM Experience Centre. This is not just an innovative and comprehensive analysis center, but one on wheels as compact Mercedes-Benz drawbar trailer truck. The Experience Centre has been fully operational since its launch in mid-October 2021 and PFM plans to demo the Retail Analytics Solution by travelling across Europe to demonstrate it to clients and at international events.



'We think it is important to provide our customers with good insight into the entire experience and scalability', emphasizes Bart Schmitz, CEO of PFM. 'There has to be room to do our presentation, we have to bring equipment and everything has to be installed. It is therefore much more convenient to take our equipment in our Experience Centre.'

To enable real-time communication between on-site sensors and PFM's cloud platform, PFM chose Robustel 5G routers which were supplied on the advice of Robustel's local channel partner Delmaton.

PFM showcases Retail Analytics in its Experience Centre at MAPIC - The international retail property market event in Cannes, France

Solution Overview

PFM have been active for almost 40 years and that they have been specialising in full-automatic measuring by means of sensor and camera techniques since 1993. The truck combination allows them to pitch their modern approach with real-time censoring on site and in practice.

PFM has installed different types of camera, sensor, radar and laser to the big digital billboard loaded on the trailer of the truck. Once they arrived in the shopping centre, the billboard can be placed inside to collect all sort of people flow data in huge volume, then transmitted to the Experience Centre via Robustel 5G IoT router R5020 to the 5G cellular network.



PFM's Digital Billboard

Solution Topology

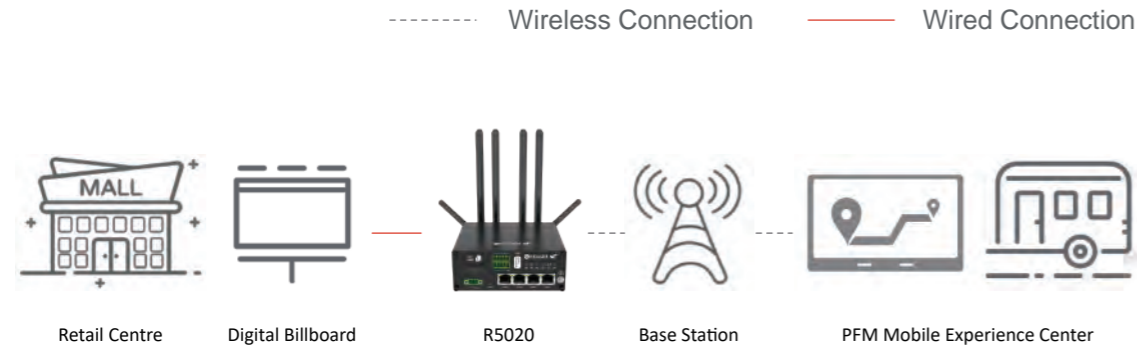

RCMS



Before using RCMS, 'we were hosting the device manager, reserve and maintain resources on our own. The number of devices and licenses were limited which was a struggle.' said I' Amie.

'Now we have RCMS with more than 100 devices connected and we are pleased with the solution. We have devices connected with the free version, but also the RCMS Advanced version so we can use the VPN tunnel. The ease of use, maintaining the devices and connecting to our sensors have improved a lot.'

ROBUSTEL FEATURED PRODUCT R5020 5G IoT Router



Robustel R5020 5G IoT router 'ensure us that connectivity is delivered throughout Europe so we can make the best impression to our visitors in our fully customized experience centre on wheels and show them the latest and greatest technology we have in-house.' said Michel I' Amie, IT & Innovations Manager at PFM.

As one of the key enablers of industrial controls, R5020 not only requires rapid response times, but also reliable and stable communication in complex industrial and harsh environments. The R5020 offers a robust industrial design alongside a rich variety of interfaces such as 4 gigabit Ethernet interfaces, I/O, 2.4 GHz and 5GHz Wi-Fi.

Ad-hoc Service

PFM also appreciate Robustel's technical support team for the 'features and especially the frequency of updates are great. Even a special request to adjust the captive portal app was delivered quickly by Robustel development team.' emphasizes I'Amie.

The fact that PFM is at the forefront of innovation is evident from the fact that they purchased the first two R5020 5G routers in the Netherlands on the advice of Delmation. 'We enjoy doing business with Delmation', emphasizes I'Amie. It is an innovative and IoT-oriented company and they share our vision for the future of technology. It's not for nothing that we have been partners in smart solutions for years.'

INTELLIGENT ROBOTIC FEEDING SYSTEM FOR MACHINERY PRODUCTION PLANT

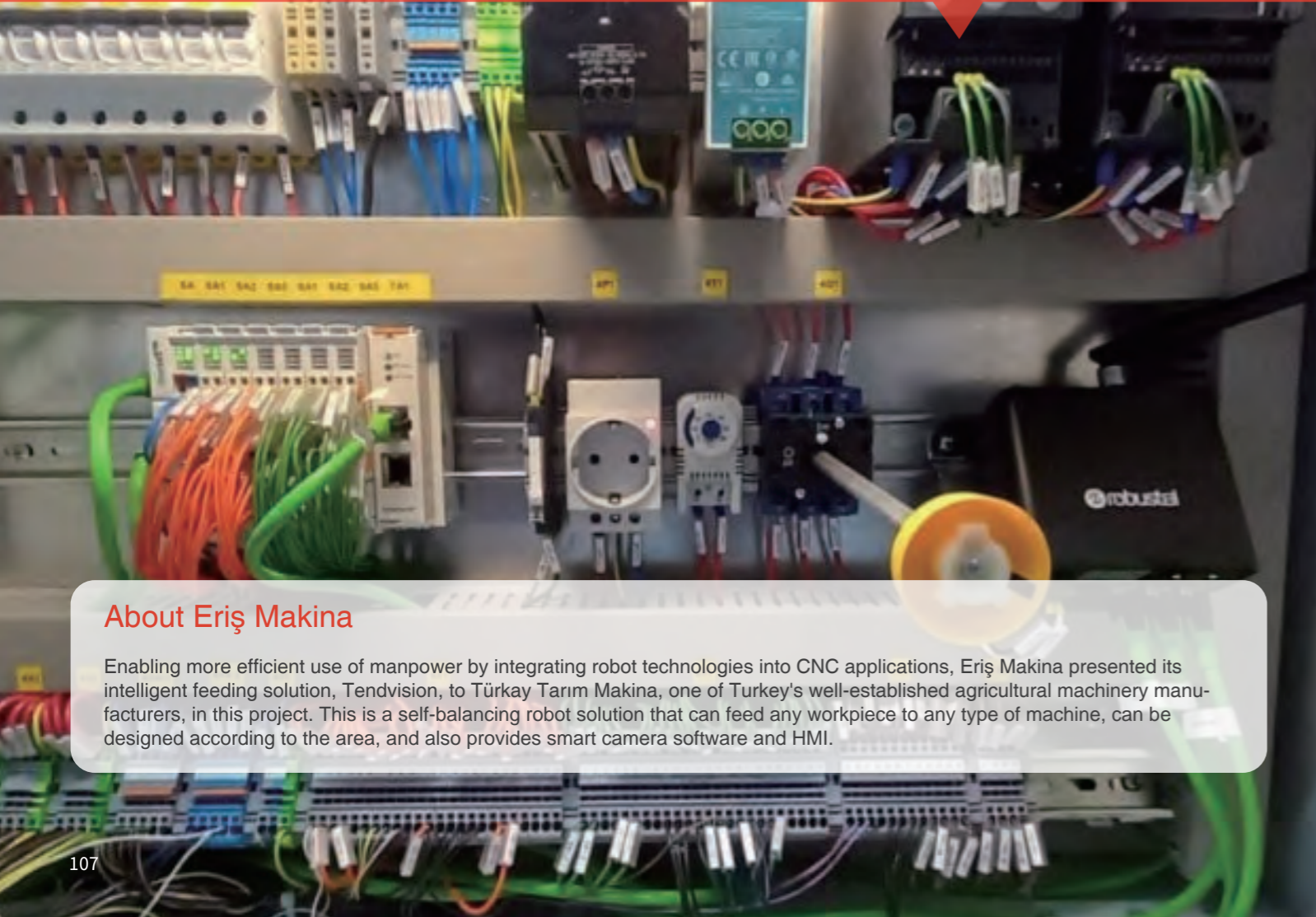

About Eriş Makina

Enabling more efficient use of manpower by integrating robot technologies into CNC applications, Eriş Makina presented its intelligent feeding solution, Tendvision, to Türkiye Tarım Makina, one of Turkey's well-established agricultural machinery manufacturers, in this project. This is a self-balancing robot solution that can feed any workpiece to any type of machine, can be designed according to the area, and also provides smart camera software and HMI.

Background Overview

CNC machines are generally for mass production and with non-stop production. For this reason, these machines must be constantly fed with raw materials. Operators used to do that feeding process manually. In the installed Tendvision system, the operator loads raw materials to the robot via the conveyor belt. Afterwards, the robot determines the location of the raw material thanks to the location information it receives from the camera on it and feeds the CNC machine at regular intervals. It stacks the processed material by taking it from the CNC machine again. In this way, the operator does not need to constantly control the raw material requirement of the CNC machine and the stacking of the processed materials, and the operation gains continuity and efficiency in production.

This critical communication system, below needs must be satisfied:

- Receiving the instant data of the robot in a healthy way;
- The working structure of the system can be controlled from anywhere at any time;
- It is of great importance that the current configuration settings of the controllers in the control panel can be changed when necessary.



Solution Overview

Robustel teamed up with the local partner GSL to meet the healthy communication need of this robot system with Robustel's R1520 Industrial Dual SIM Cellular VPN Router and Robustel Cloud Manager Service (RCMS), which offers a variety of ports and interface options, with the advantages of high speed and low cost.

Tendvision, which is connected to the R1520 router, can control the working structure of the entire system supported by the smart camera and industrial PC, and can make changes to the system settings when necessary.



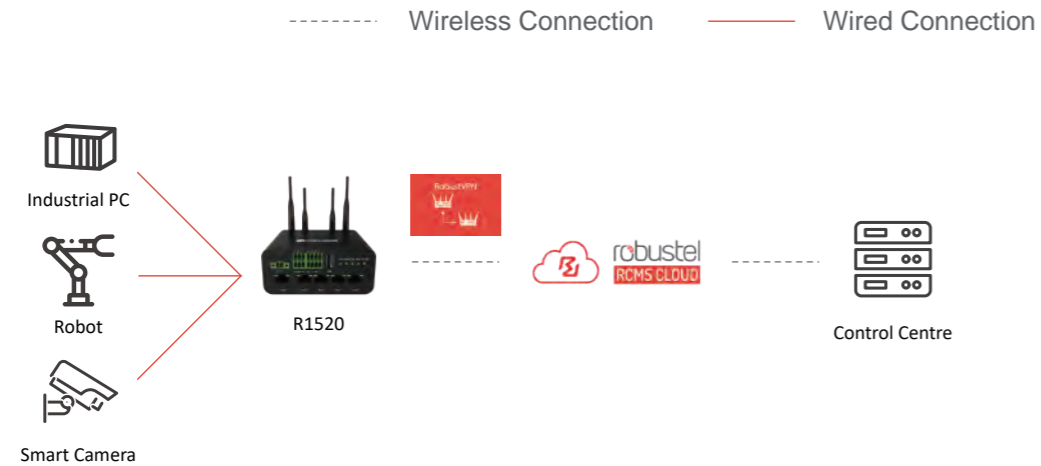

Solution Benefits

In this project, by using the RobustVPN feature offered by the RCMS offered with the Robustel R1520, all devices can be accessed from any remote location and the data of the robot can be observed instantly. By connecting to the camera on the robot, the status of the system can be observed and its functioning can be monitored. In addition, by connecting to an industrial PC, the settings on the controller can be seen and changes can be made remotely if needed.

Accessing the Tendvision system from remote computers via remote desktop access applications such as Anydesk and Teamviewer will both negatively affect the performance of the computer and cause a decrease in connection speed. By using the RobustVPN feature offered by RCMS in the project, these disadvantages are avoided as it enables to connect to the industrial PC as if it were in the local network.