

R1520LG

Hardware Manual

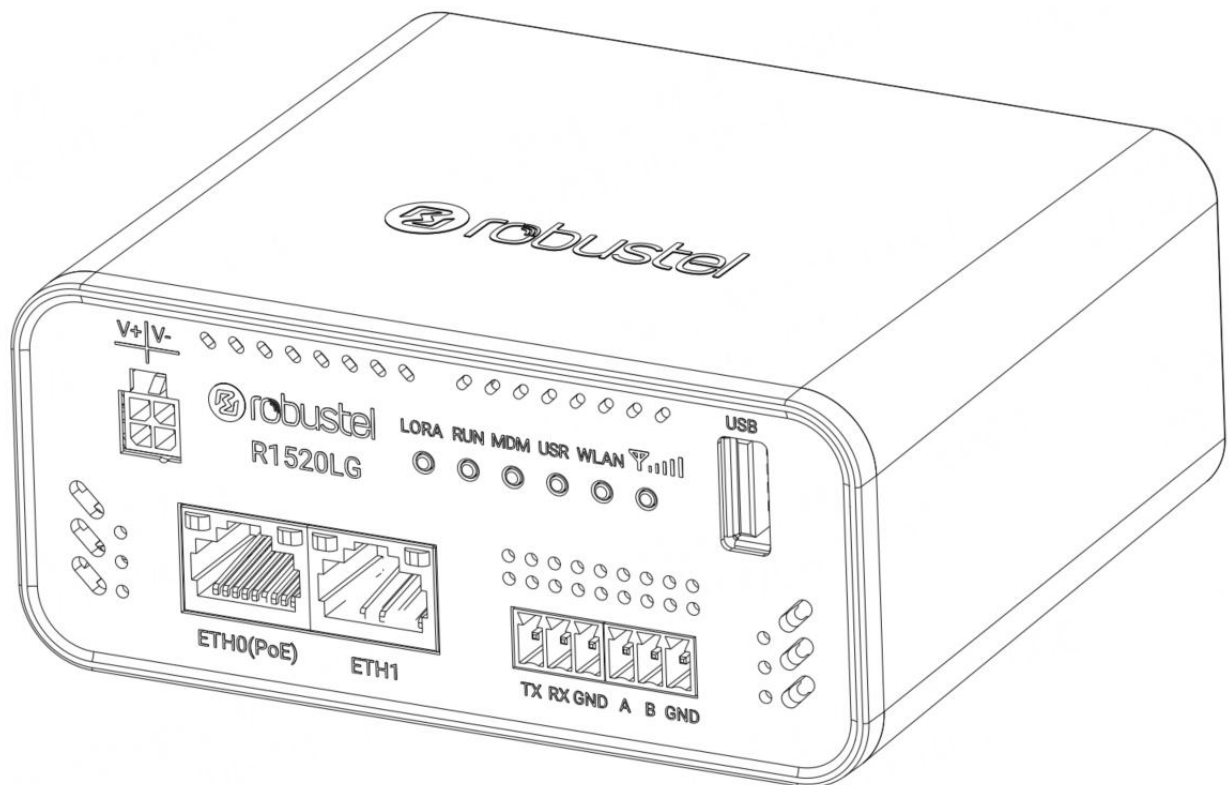

Version: 1.0.1

Date: May 24, 2024

Regulatory and Type Approval Information

Table 1: Toxic or Hazardous Substances or Elements with Defined Concentration Limits

Name of the Part	Hazardous Substances									
	(Pb)	(Hg)	(Cd)	(Cr(VI))	(PBB)	(PBDE)	(DEHP)	(BBP)	(DBP)	(DIBP)
Metal parts	X	o	o	o	-	-	-	-	-	-
Circuit modules	o	o	o	o	o	o	o	o	o	o
Cables and cable assemblies	o	o	o	o	o	o	o	o	o	o
Plastic and polymeric parts	o	o	o	o	o	o	o	o	o	o

o:
Indicates that this toxic or hazardous substance contained in all of the homogeneous materials for this part is below the limit requirement in RoHS2.0.

X:
Indicates that this toxic or hazardous substance contained in at least one of the homogeneous materials for this part *might exceed* the limit requirement in RoHS2.0.

-:
Indicates that it does not contain the toxic or hazardous substance.

Note: Excessive lead can be exempted.
1.Copper alloy containing up to 4 % lead by weight (RoHS Exemption 6(c)).
2.Electrical and electronic components containing lead in a glass or ceramic other than dielectric ceramic in capacitors, e.g. piezoelectronic devices, or in a glass or ceramic matrix compound (ROHS Exemption7(c)- I).

Radio Specifications for Europe

RF technologies	2G, 3G, 4G, Wi-Fi, Bluetooth, LoRa
Cellular Frequency*	4G: LTE FDD: B1/B3/B5/B7/B8/B20/B28 LTE TDD: B34/B38/B40/B41 3G: WCDMA: B1/B5/B8 2G: GSM900/DCS1800
Wi-Fi Frequency	2.4 GHz: 2.412 ~ 2.462 GHz
Bluetooth Frequency	2402 ~ 2480 MHz
LoRa Frequency*	863-870 MHz
Max RF power	33 dBm ±2 dB@GSM900, 30 dBm ±2dB@DCS1800, 23 dBm ±2 dB@WCDMA, 23 dBm ±2 dB@LTE, 19.32 dBm@2.4GHz Wi-Fi, 8.24 dBm@BT, 12.58 dBm@BLE, 14 dBm ±2 dB@LoRa

* *May vary on difference models.*

Caution: The user is cautioned that changes or modifications not expressly approved by the party responsible for compliance could void the user's authority to operate the equipment.

This device contains licence-exempt transmitter(s)/receiver(s) that comply with Innovation, Science and Economic Development Canada's licence-exempt RSS(s) and Part 15 of the FCC Rules. Operation is subject to the following two conditions:

- (1) This device may not cause interference.
- (2) This device must accept any interference, including interference that may cause undesired operation of the device.

L'émetteur/récepteur exempt de licence contenu dans le présent appareil est conforme aux CNR d'Innovation, Sciences et Développement économique Canada applicables aux appareils radio exempts de licence. L'exploitation est autorisée aux deux conditions suivantes :

- (1) L'appareil ne doit pas produire de brouillage;
- (2) L'appareil doit accepter tout brouillage radioélectrique subi, même si le brouillage est susceptible d'en compromettre le fonctionnement.

Note: This equipment has been tested and found to comply with the limits for a Class B digital device, pursuant to Part 15 of the FCC Rules. These limits are designed to provide reasonable protection against harmful interference in a residential installation. This equipment generates, uses and can radiate radio frequency energy and, if not installed and used in accordance with the instructions, may cause harmful interference to radio communications. However, there is no guarantee that interference will not occur in a particular installation.

If this equipment does cause harmful interference to radio or television reception, which can be determined by turning the equipment off and on, the user is encouraged to try to correct the interference by one or more of the following measures:

- Reorient or relocate the receiving antenna.
- Increase the separation between the equipment and receiver.
- Connect the equipment into an outlet on a circuit different from that to which the receiver is connected.
- Consult the dealer or an experienced radio/TV technician for help.

FCC& IC Radiation Exposure Statement

This equipment complies with FCC and Canada radiation exposure limits set forth for an uncontrolled environment. This equipment should be installed and operated with a minimum distance of 20cm between the radiator and your body.

This transmitter must not be co-located or operating in conjunction with any other antenna or transmitter.

Déclaration d'IC sur l'exposition aux radiations

Cet équipement est conforme aux limites d'exposition aux radiations définies par le Canada pour des environnements non contrôlés. Cet équipement doit être installé et utilisé à une distance minimum de 20 cm entre l'antenne et votre corps.

Cet émetteur ne doit pas être installé au même endroit ni utilisé avec une autre antenne ou un autre émetteur.

Simplified EU & UK Declaration of Conformity

We, Guangzhou Robustel Co., Ltd. are located at 501, Building #2, 63 Yongan Road, Huangpu District, Guangzhou, China, declare that this radio equipment complies with EU Radio Equipment Directive (RED) 2014/53/EU, Low Voltage Directive (LVD) 2014/35/EU, EMC Directive 2014/30/EU, UK Radio Equipment Regulations 2017, EMC Regulations 2016, Electrical Equipment (Safety) Regulations 2016. The full text of the EU& UK DoC is available at the following internet address:

www.robustel.com/certifications/

Safety Information

General

- The router generates radio frequency (RF) power. When using the router, care must be taken on safety issues related to RF interference as well as regulations of RF equipment.
- Do not use your router in aircraft, hospitals, petrol stations or in places where using cellular products is prohibited.
- Be sure that the router will not be interfering with nearby equipment. For example: pacemakers or medical equipment. The antenna of the router should be away from computers, office equipment, home appliance, etc.
- An external antenna must be connected to the router for proper operation. Only uses approved antenna with the router. Please contact authorized distributor on finding an approved antenna.

RF Exposure

- This device meets the official requirements for exposure to radio waves. This device is designed and manufactured not to exceed the emission limits for exposure to radio frequency (RF) energy set by authorized agencies.
- The device must be used with a minimum separation of 20 cm from a person's body to ensure compliance with RF exposure guidelines. Failure to observe these instructions could result in your RF exposure exceeding the applicable limits.

Note: Some airlines may permit the use of cellular phones while the aircraft is on the ground and the door is open. Router may be used at this time.



The symbol indicates that the product should not be mixed with general household waste but must be sent to separate collection facilities for recovery and recycling.



The symbol indicates that the product meets the requirements of the applicable EU directives.



The symbol indicates that the product meets the requirements of the relevant UK legislation.

⚠ WARNING:

This product can expose you to chemicals including Lead, known to the State of California to cause cancer and birth defects or other reproductive harm. For more information go to www.P65Warnings.ca.gov.

Related download link

Find more product documents or tools at:

www.robustel.com/documentation/

Technical Support

Tel: 400-987-3791

Email: support@robustel.com

Web: www.robustel.com

Document History

Updates between document versions are cumulative. Therefore, the latest document version contains all updates made to previous versions.











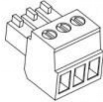

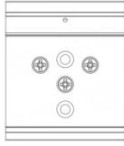
Date	Document Version	Change Description
Mar. 06, 2024	1.0.0	Initial release.
May 24, 2024	1.0.1	Added warning description for California65

Overview

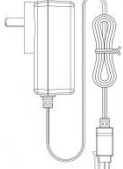
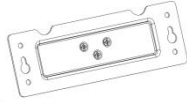
R1520LG, as a new generation Industrial-grade LoRa gateway, not only supports 4G/3G/2G but also features WiFi and POE-PD capabilities, providing a robust and reliable connectivity solution for industrial applications. With an integrated Chirpstack LoRa network server and equipped with a cutting-edge LoRa chip, this high-performance 8-channel gateway boasts outstanding performance in high-traffic management and remarkable advantages in low power consumption.

Package Checklist

Before commencing installation ensure your package has the following components:

<p>Device</p> 	<p>3PIN Terminal Block</p> 	<p>SIM Card Sticker</p> 	<p>Mounting Kit</p> 	<p>RCMS Card</p> 
<p>Quick Start Guide Card</p> 	<p>QC Card</p> 	<p>Power Supply (Optional)</p> 	<p>Mounting Kit (Optional)</p> 	<p>Wi-Fi Antenna (Optional)</p> 
<p>Cellular Antenna (Optional)</p> 	<p>Lora Antenna (Optional)</p> 	<p>Ethernet Cable (Optional)</p> 	<p>Power Cable (Optional)</p> 	

Note: The accessories could be different on specific order.

Panel Layout

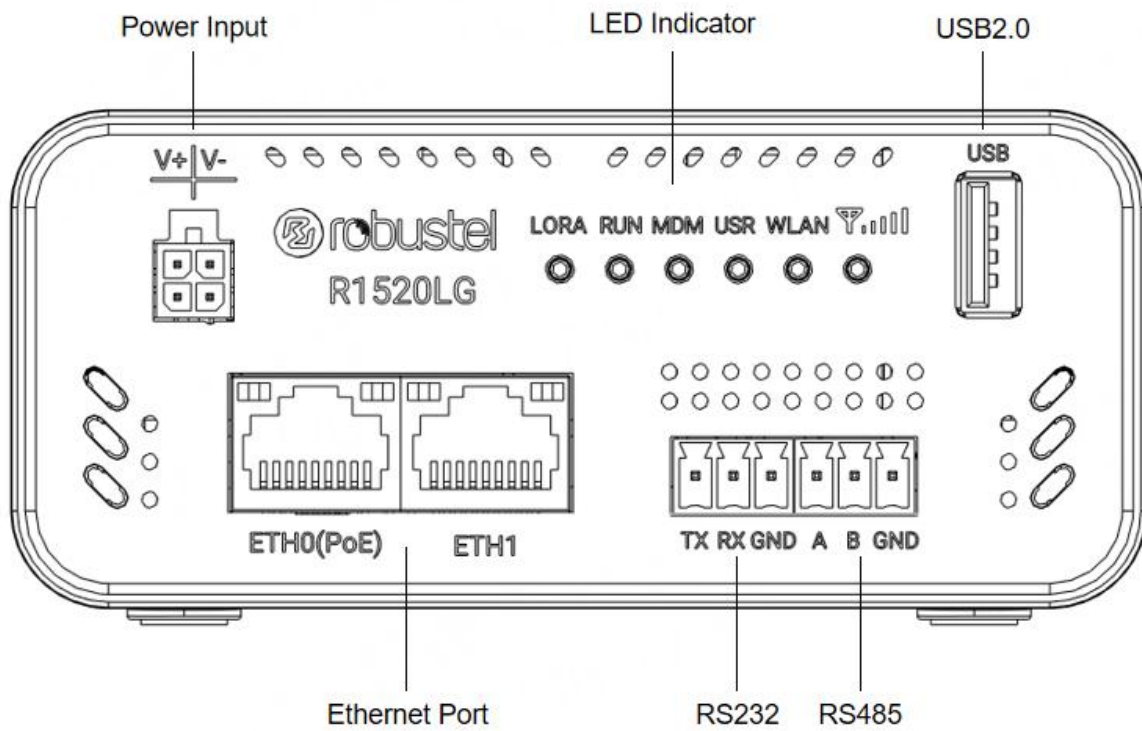

Front View

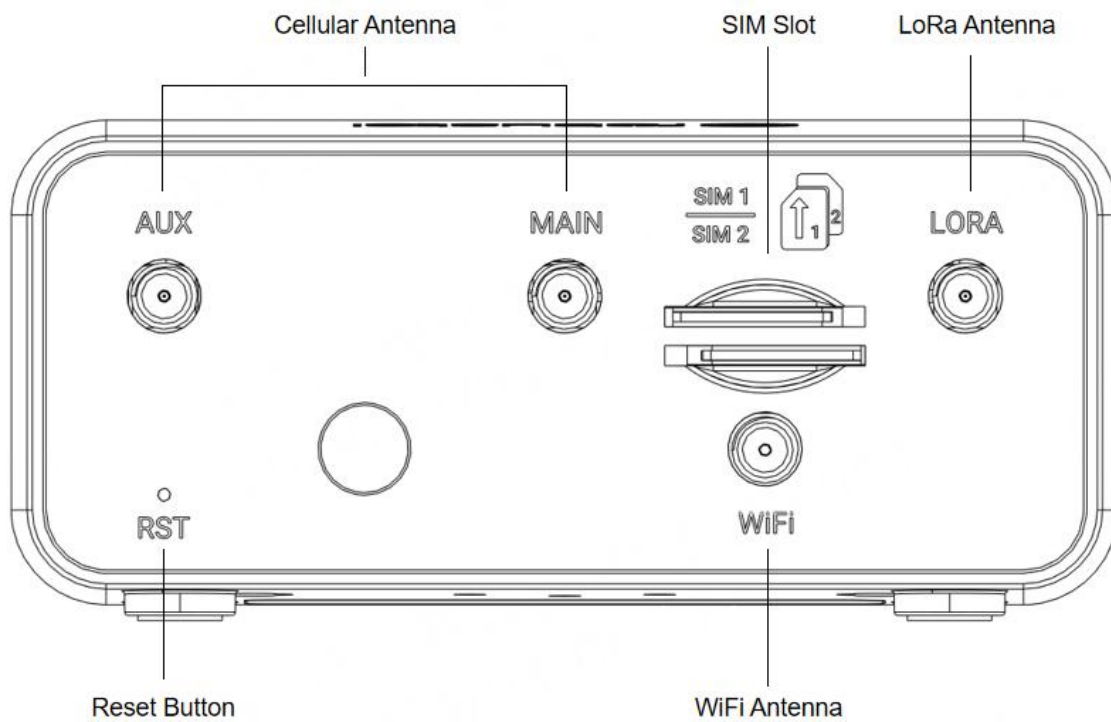

Back View

Interface Descriptions

1. PIN Description.

PIN	Description	Note
1	V+	Power
2	V-	Ground
3	NC	--
4	NC	--

Note: The input voltage is 9 to 60V DC.

2. Serial Ports.

PIN	Description	Note
1	TXD	RS232 Data Transmission
2	RXD	RS232 Data Receive
3	GND	Ground
4	A	RS485 Data Transmission
5	B	RS485 Data Receive
6	GND	Ground

3. Ethernet Ports. Two Ethernet ports, both of them could be configured as WAN or LAN.

	Description	
Activity	On, blinking	Transmitting data
	Off	No activity
Link	On	Link on
	Off	Link off

4. Reset Button.

Function	Operation
Reboot	Press and hold the RST button for 2~5 seconds under the operating status.
Restore to default configuration	Press and hold the RST button for 5 ~10 seconds under the operating status. The RUN light flashes quickly, and then release the RST button, and the device will restore to the default configuration.
Restore to factory configuration	Once the operation of restoring the default configuration is performed twice within one minute, the device will restore to the factory default settings.

5. LED Indicators.

LED	Description	
RUN	On, solid	Gateway system is initializing
	On, blinking	Gateway starts operating
	Off	Gateway is powered off
MDM	On, solid	Connected successfully
	On, blinking	In communication
	Off	Disconnected
	On, solid	Strong signal
	On, blinking (fast)	Medium signal
	On, blinking (slowly)	Weak or no signal
<i>Note: The RSSI LED's color is Green</i>		
WLAN	On, solid	Connected successfully
	On,blinking	In communication
	Off	Disconnected
LoRa	On, solid	Connected successfully
	On,blinking	In communication
	Off	Disconnected

Note: The USR LED is defined by user via web UI to specify different status, the details see the following sheet.
web UI address : Services > Advanced > System >System Settings > User LED Type.

USR type	Description	
IPsec	On, solid	IPsec connection is established
	Off	IPsec connection is not established
OpenVPN	On, solid	OpenVPN connection is established
	Off	OpenVPN connection is not established
PPTP	On, solid	PPTP connection is established
	Off	PPTP connection is not established
LT2P	On, solid	LT2P connection is established
	Off	LT2P connection is not established

Note: The USR LED's color is green.

Hardware Installation

1. **SIM Card Installation.** Insert the SIM cards into the device and paste SIM card cover sticker if needed.

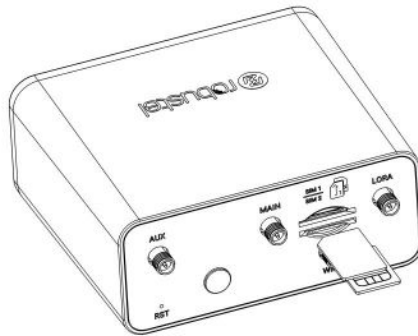

2. **Antenna Installation.** Rotate the antenna into the antenna connector accordingly.

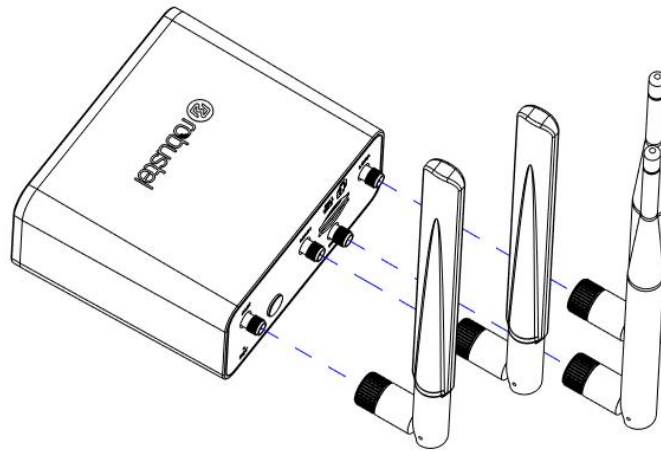

3. **Terminal Block Installation.** Insert the 2x3PIN terminal blocks into the interfaces connector, then can connect the devices or sensors to the gateway with wires via corresponding interfaces e.g. RS232, RS485.

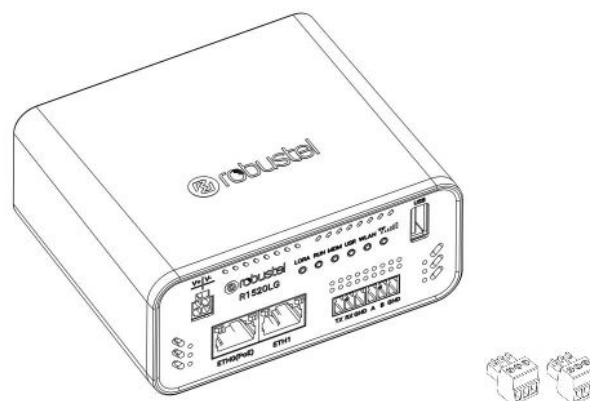

4. **Power Supply installation.** Insert the power supply cord into the power connector.

5. **Connect the router to the computer.** Connect the Ethernet cable to any port labeled ETH0 or ETH1 of the gateway, and connect the other end of the cable to your computer.

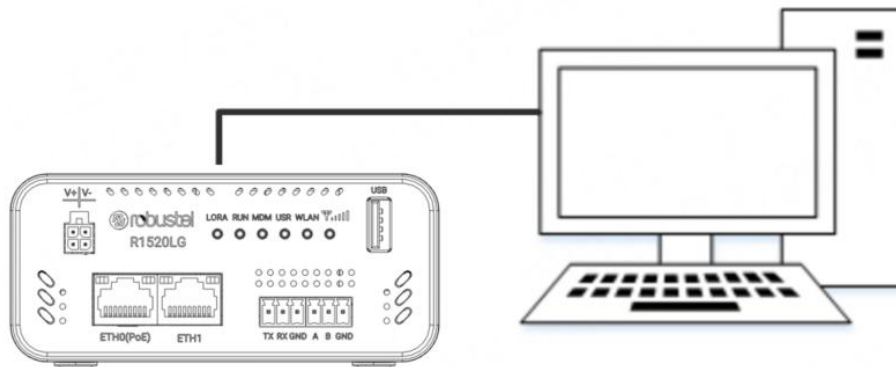

6. **DIN Rail Mounting.** Use 3 M3 screws to fix the DIN rail to the device, then hang the DIN rail on the mounting bracket.

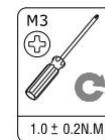
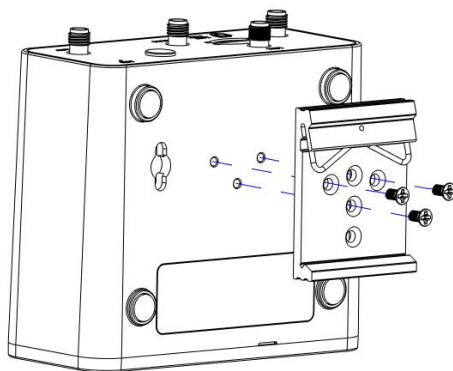

7. **Wall Mounting.** Use 3 M3 screws to fix the Wall mounting to the device.

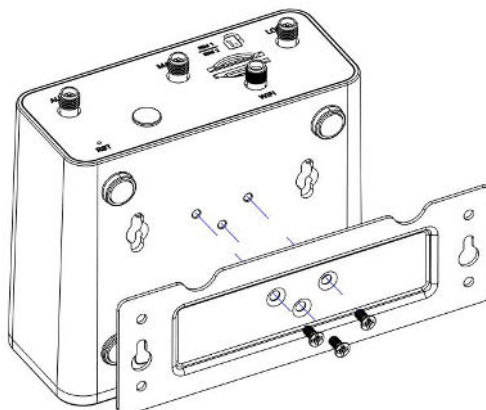

Login to the Device

1. Connect the gateway’s Ethernet port to a PC with a standard Ethernet cable.
2. Before logging in, manually configure the PC with a static IP address on the same subnet as the gateway address, click and configure "Use the following IP address".

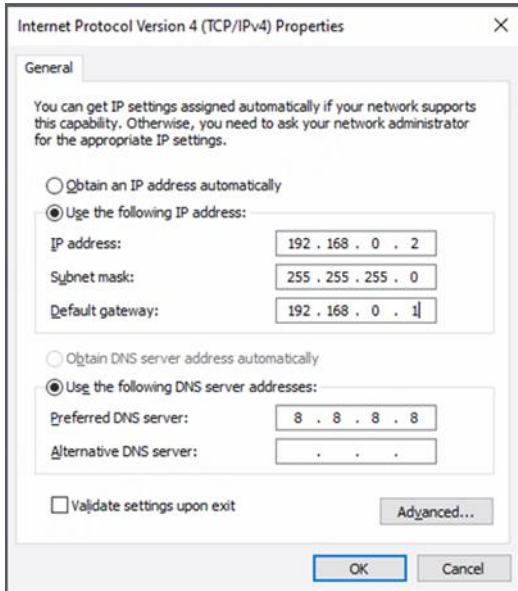

3. To enter the gateway's web interface, type <http://192.168.0.1> into the URL field of your Internet browser.
4. Use login information shown in the product label when prompted for authentication.



5. After logging in, the home page of the web interface is displayed, then you can view system information and perform configuration on the device.

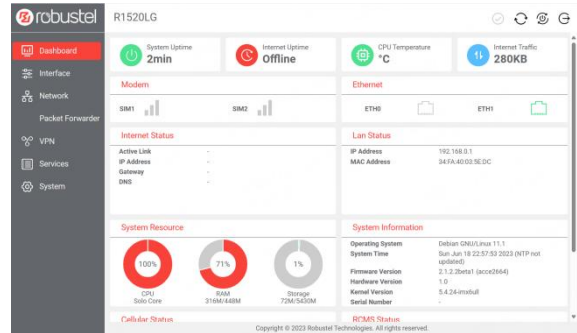

6. The automatic APN selection is ON by default, if need to specify your own APN, please go to the menu **Interface->Cellular->Advanced Cellular Setting->General Settings** to finish the specific setting.

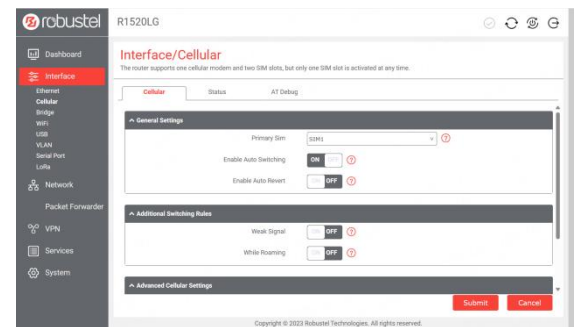

7. For more configuration details please refer to **RT104_SM_RobustOS Pro Software Manual**. (END)