

EG5200

Hardware Manual

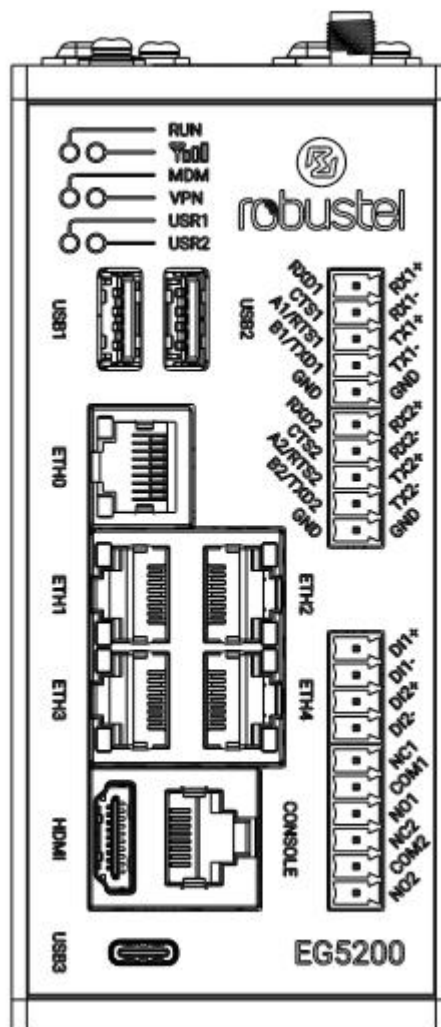

Version: 1.0.1

Date: December 18, 2024

Regulatory and Type Approval Information

Table 1: Toxic or Hazardous Substances or Elements with Defined Concentration Limits

Name of the Part	Hazardous Substances									
	(Pb)	(Hg)	(Cd)	(Cr(VI))	(PBB)	(PBDE)	(DEHP)	(BBP)	(DBP)	(DIBP)
Metal parts	o	o	o	o	-	-	-	-	-	-
Circuit modules	o	o	o	o	o	o	o	o	o	o
Cables and cable assemblies	o	o	o	o	o	o	o	o	o	o
Plastic and polymeric parts	o	o	o	o	o	o	o	o	o	o

o:
Indicates that this toxic or hazardous substance contained in all of the homogeneous materials for this part is below the limit requirement in RoHS2.0.

X:
Indicates that this toxic or hazardous substance contained in at least one of the homogeneous materials for this part *might exceed* the limit requirement in RoHS2.0.

-:
Indicates that it does not contain the toxic or hazardous substance.

Radio Specifications for Europe

RF technologies	2G, 3G, 4G, 5G, GNSS*, Wi-Fi*, BT*	
4G Cellular Frequency*	EU Band: 4G: LTE FDD: B1/B3/B7/B8/B20/B28/B32 LTE TDD: B34/B38/B40/B42/B43/B46 3G: WCDMA: B1/B8 2G: GSM: B3/B8	Non-EU Band: 4G: LTE FDD: B2/B4/B5/B12/B13/B18/B19 /B25/B26 LTE TDD: B39/B41 3G: WCDMA: B2/B4/B5/B6/B19 2G: GSM: B2/B5
5G Cellular Frequency *	5G: NR SA/NSA: n1/n2/n3/n5/n7/n8/n12/n13/n14/n20/n25/n26/n28/n29/n30/n38/n40/n41/n48/n66/n71/n75/n76/n77/n78/n79 4G: LTE FDD: B1/B2/B3/B4/B5/B7/B8/B12/B13/B14/B17/B18/B19/B20/B25/B26/B28/B29/B30/B32/B66/B71 LTE TDD: B34/B38/B39/B40/B41/B42/B43/B48 LAA: B46 3G: WCDMA: B1/B2/B4/B5/B8/B19	

Wi-Fi Frequency	2.4 GHz: 2.412 ~ 2.472 GHz 5 GHz: 5150-5350 MHz, 5470 ~ 5725 MHz, 5745-5825 MHz
BT Frequency	2400 ~ 2483.5MHz
GNSS*	GPS L1, Galileo E1, GLONASS G1, BDS B1I, SBAS L1: 1559MHz to 1610MHz BDS B2a, GPS L5, Galileo E5a: 1164MHz to 1215MHz
4G Cellular Max RF power	33 dBm±2dB@GSM, 24 dBm+1/-3dB@WCDMA, 23 dBm±2dB@LTE
5G Cellular Max RF power	<ul style="list-style-type: none"> ● UTRA FDD Band I/VIII: 25 dBm ● E-UTRA FDD 1/3/7/8/20/28: 25 dBm ● E-UTRA TDD 34/38/40/42/43: 25 dBm ● UL CA: 25 dBm ● LTE B38/B40/B41/B42/B43 (class 2): 28dBm 5G NR Standalone and Non-Standalone: <ul style="list-style-type: none"> ● n1/n3/n7/n8/n20/n28: 25dBm ● n38/n40/n41/n77/n78 (class 2): 28dBm
Other RF power	EIRP BLE<10 dBm, EIRP 2.4 GHz<20 dBm, EIRP 5 GHz<23 dBm, EIRP 5.8 GHz<13.98 dBm

* *May vary on difference models.*

Note: Operation of 5150 ~ 5350 MHz frequency range is restricted to indoor use only.

電波法の規定により 5GHz 帯は屋内使用に限ります。

	AT	BE	BG	CH	CY	CZ	DE	DK
	EE	EL	ES	FI	FR	HR	HU	IE
	IS	IT	LI	LT	LU	LV	MT	NL
	NO	PL	PT	RO	SE	SI	SK	UK

Caution: The user is cautioned that changes or modifications not expressly approved by the party responsible for compliance could void the user's authority to operate the equipment.

This device contains licence-exempt transmitter(s)/receiver(s) that comply with Innovation, Science and Economic Development Canada’s licence-exempt RSS(s) and Part 15 of the FCC Rules. Operation is subject to the following two conditions:

- (1) This device may not cause interference.
- (2) This device must accept any interference, including interference that may cause undesired operation of the device.

L'émetteur/récepteur exempt de licence contenu dans le présent appareil est conforme aux CNR d'Innovation, Sciences et Développement économique Canada applicables aux appareils radio exempts de licence. L'exploitation est autorisée aux deux conditions suivantes :

- (1) L'appareil ne doit pas produire de brouillage;
- (2) L'appareil doit accepter tout brouillage radioélectrique subi, même si le brouillage est susceptible d'en compromettre le fonctionnement.

Caution: Changes or modifications not expressly approved by the party responsible for compliance could void the user's authority to operate the equipment.

Note: This equipment has been tested and found to comply with the limits for a Class A digital device, pursuant to part 15 of the FCC Rules. These limits are designed to provide reasonable protection against harmful interference

when the equipment operated in a commercial environment. This equipment generates, uses, and can radiate radio frequency energy and, if not installed and used in accordance with the instruction manual, may cause harmful interference to radio communications. Operation of this equipment in a residential area is likely to cause harmful interference in which case the user will be required to correct the interference at his own expense.

FCC& IC Radiation Exposure Statement

This equipment complies with FCC and Canada radiation exposure limits set forth for an uncontrolled environment. This equipment should be installed and operated with a minimum distance of 20cm between the radiator and your body.

This transmitter must not be co-located or operating in conjunction with any other antenna or transmitter.

Déclaration d'IC sur l'exposition aux radiations

Cet équipement est conforme aux limites d'exposition aux radiations définies par le Canada pour des environnements non contrôlés. Cet équipement doit être installé et utilisé à une distance minimum de 20 cm entre l'antenne et votre corps.

Cet émetteur ne doit pas être installé au même endroit ni utilisé avec une autre antenne ou un autre émetteur.

Simplified EU Declaration of Conformity

We, Guangzhou Robustel Co., Ltd. are located at 501, Building #2, 63 Yongan Road, Huangpu District, Guangzhou, China, declare that this radio equipment complies with all applicable EU directives. The full text of the EU DoC is available at the following internet address:

www.robustel.com/certifications/

Safety Information

General

- The router generates radio frequency (RF) power. When using the router, care must be taken on safety issues related to RF interference as well as regulations of RF equipment.
- Do not use your router in aircraft, hospitals, petrol stations or in places where using cellular products is prohibited.
- Be sure that the router will not be interfering with nearby equipment. For example: pacemakers or medical equipment. The antenna of the router should be away from computers, office equipment, home appliance, etc.
- An external antenna must be connected to the router for proper operation. Only uses approved antenna with the router. Please contact authorized distributor on finding an approved antenna.

RF Exposure

- This device meets the official requirements for exposure to radio waves. This device is designed and manufactured not to exceed the emission limits for exposure to radio frequency (RF) energy set by authorized agencies.
- The device must be used with a minimum separation of 20 cm from a person's body to ensure compliance with RF exposure guidelines. Failure to observe these instructions could result in your RF exposure exceeding the applicable limits.

Note: Some airlines may permit the use of cellular phones while the aircraft is on the ground and the door is open. Router may be used at this time.



The symbol indicates that the product should not be mixed with general household waste but must be sent to separate collection facilities for recovery and recycling.



The symbol indicates that the product meets the requirements of the applicable EU directives.



The symbol indicates that the product meets the requirements of the relevant UK legislation.

Related download link

Find more product documents or tools at:

www.robustel.com/documentation/

Technical Support

Tel: +86-20-82321505

Email: support@robustel.com

Web: www.robustel.com

Document History

Updates between document versions are cumulative. Therefore, the latest document version contains all updates made to previous versions.









Date	Document Version	Change Description
Jun. 27, 2023	1.0.0	Initial release.
Dec.18, 2024	1.0.1	<ol style="list-style-type: none"> 1. Updated 5G Cellular Max RF power. 2. Changed EMI to Class A and added a warning statement. 3. Added the Nano SIM adapter to the package checklist. 4. Removed the "DC9~60VDC" from the panel diagram. 5. Added a power supply description under the Interfaces section. 6. Added an application diagram for relay output. 7. Added a description for lead content exceeding the limit exemption. 8. Optimized the product accessory information and descriptions. 9. Added a 5G SKU. 10. Updated the WiFi and Bluetooth power specifications.

Overview

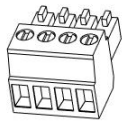
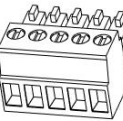
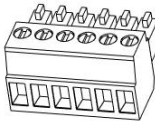
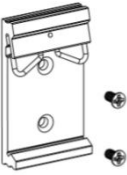
EG5200 is a new generation of industrial edge computing gateway, supporting global 5G/4G/3G/2G networks for cellular backhaul, with a fully-fledged Debian 11(bullseye) based operating system able to support thousands of existing or new ARMv8 (Raspberry Pi compatible) based applications.

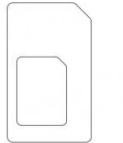
Package Checklist

Before commencing installation ensure your package has the following components:

<p>Device</p>	<p>2PIN Terminal Block with Lock</p>	<p>4PIN Terminal Block</p>	<p>5PIN Terminal Block</p>	<p>6PIN Terminal Block</p>
				
<p>Mounting Kit</p>	<p>RCMS Card</p>	<p>Quick Start Guide Card</p>	<p>Nano SIM Adapter</p>	<p>Wi-Fi Antenna (Optional)</p>
				
<p>Cellular Antenna (Optional)</p>	<p>Power Supply (Optional)</p>			
				

Note: The accessories could be different on specific order.

Panel Layout

(May vary on different models, please refer to Table1)

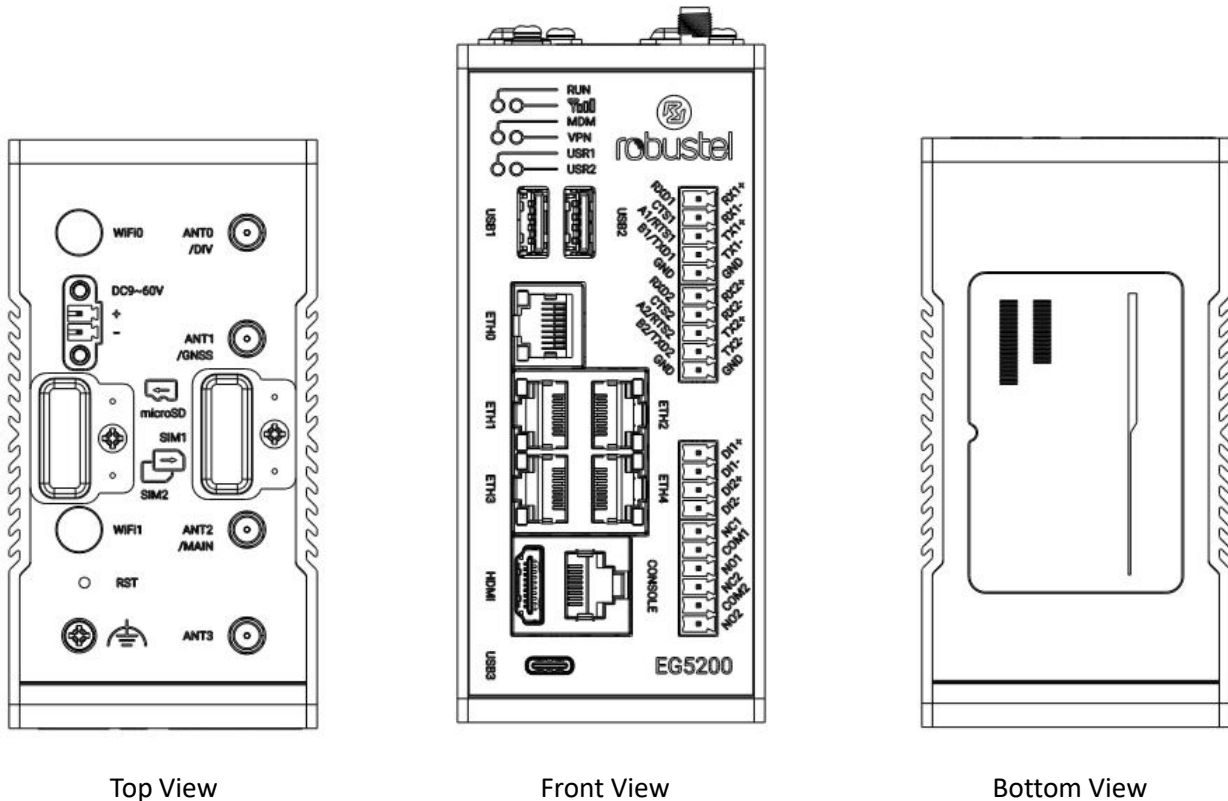

Table1

Model	PN	Cellular Antenna Port	WiFi/BLE Antenna Port	GNSS Antenna Port
EG5200-A5ZAZ-NU	B120001	0	0	0
EG5200-A5CAZ-NU	B120002	0	2	0
EG5200-A5AAZ-4L-A06GL_EG25-G	B120004	2	0	1
EG5200-A5BAZ-4L-A06GL_EG25-G	B120006	2	2	1
EG5200-A5AAZ-5G-A25GL_RM520N-GL	B120003	4	0	0
EG5200-A5BAZ-5G-A25GL_RM520N-GL	B120005	4	2	0

Interface Descriptions

1. **Serial Ports.** Two software configurable serial ports, could be configured as RS232 or RS485 or RS422.

Name	RS232 Mode	RS485 Mode	RS422 Mode
RXD1 or RX1+	data receiving		data receiving positive
CTS1 or RX1-	clear to send		data receiving negative
A1/RTS1 or TX1+	request to send	RS485_A1	data sending positive
B1/TXD1 or TX1-	data sending	RS485_B1	data sending negative
GND	Ground	Ground	Ground
RXD2 or RX2+	data receiving		data receiving positive
CTS2 or RX2-	clear to send		data receiving negative
A2/RTS2 or TX2+	request to send	RS485_A2	data sending positive
B2/TXD2 or TX2-	data sending	RS485_B2	data sending negative
GND	Ground	Ground	Ground

2. **Ethernet Ports.** 5 Ethernet ports, both of them could be configured as WAN or LAN.

LED	Description	
Activity	On, blinking	Transmitting data
	Off	No activity
Link	Off	Link off
	On	Link on

3. **Reset Button.**

Function	Operation
Reboot	Press and hold the RST button for 2~5 seconds under the operating status.
Restore to default configuration	Press and hold the RST button for 5 ~10 seconds under the operating status. The RUN light flashes quickly, and then release the RST button, and the device will restore to the default configuration.
Restore to factory configuration	Once the operation of restoring the default configuration is performed twice within one minute, the device will restore to the factory default settings.

4. **Power Supply.** DC power supply, range from 12VDC ~60VDC, recommend to use 24VDC as .

Name	Description
+	DC Power positive
-	DC Power negative

5. **Digital Input and Relay Output.** Two sets of digital inputs and two sets of Relay outputs.

Name	Type	Description
DI1+	Digital I/O	Digital Input positive
DI1-		Digital Input negative
DI2+		Digital Input positive
DI2-		Digital Input negative
NC1	Relay Output	Normally Closed
COM1		Common
NO1		Normally Open
NC2		Normally Closed
COM2		Common
NO2		Normally Open

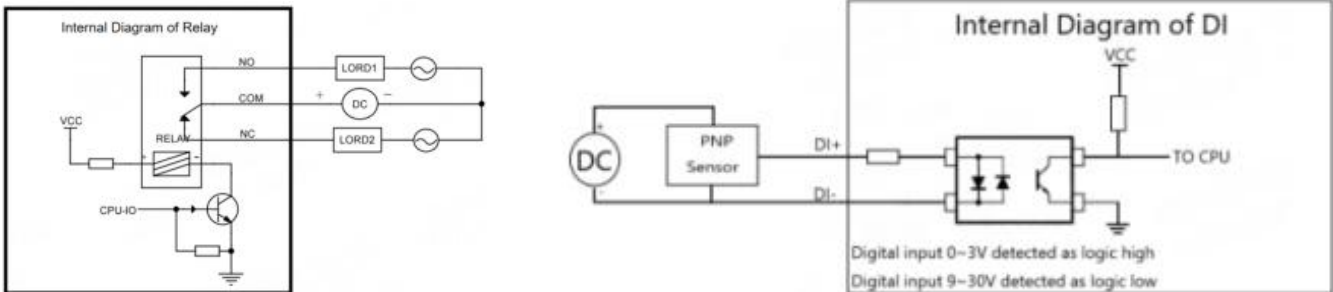

- Note:**
- When the relay is off, NC is connected to COM, and NO is disconnected. The external power supply input voltage range is DC 5-48V, with a maximum load current of 300mA.
 - For digital input, the external power supply DC voltage range is 5V~30V, 0.1A max.

6. **LED Indicators.**

LED	Description	
RUN	On, solid	Gateway system is initializing
	On, blinking	Gateway starts operating
	Off	Gateway is powered off
MDM	Color	With 4G Module: 2G: Red, 3G: Yellow, 4G: Green With 5G Module: 3G: Red, 4G: Yellow, 5G: Green
	On, blinking	Link connection is working
	Off	Link connection is not working
	Green	Strong signal
	Yellow	Medium signal
	Red	Weak or no signal
VPN	On, solid	VPN connection is established
	Off	VPN connection is not established
USR1/USR2	Defined by user. For more details, please refer to RT_SM_RobustOS Pro_ Software Manual: Services > Advanced > System > System Settings > User LED Type.	

Hardware Installation

- SIM Card Installation.** Remove the SIM card cover to insert the SIM cards into the device, then screw up the cover.

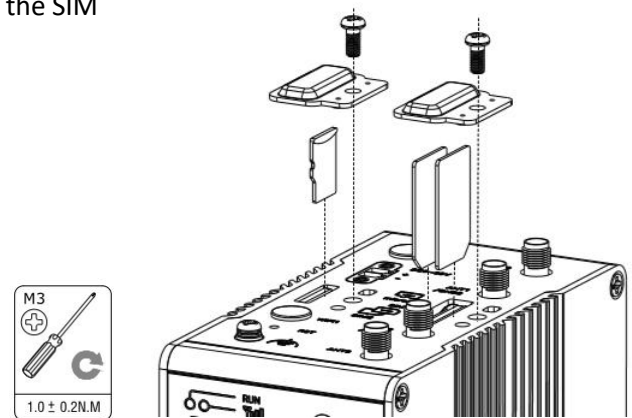

- Antenna Installation.** Rotate the antenna into the antenna connector accordingly.

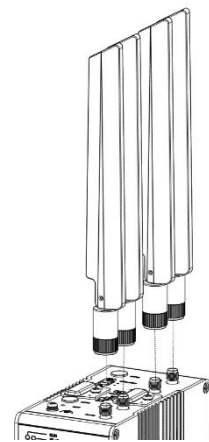

Rubber Antenna Installation

- Terminal Block Installation.** Insert the 4 PIN, 5PIN and 6PIN terminal blocks into the interfaces connector, then can connect the devices or sensors to the gateway with wires via corresponding interfaces.

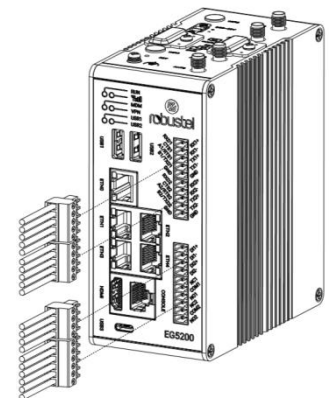

4. **Power Supply installation.** Insert the power supply cord into the corresponding terminal block if needed, then insert the terminal block into the power connector.

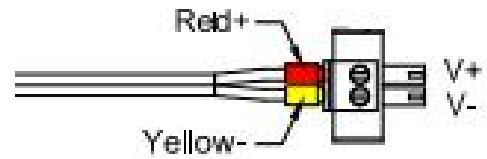

5. **DIN Rail Mounting.** Use 2 M3 screws to fix the DIN rail to the device, then hang the DIN rail on the mounting bracket.

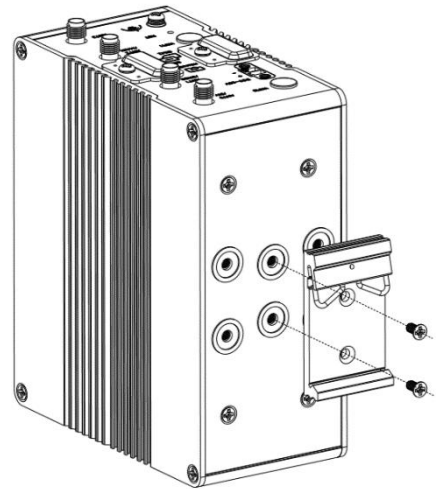

6. **Wall Mounting.** Use 4 M3 screws to fix the DIN rail to the device, then hang the DIN rail on the mounting bracket.

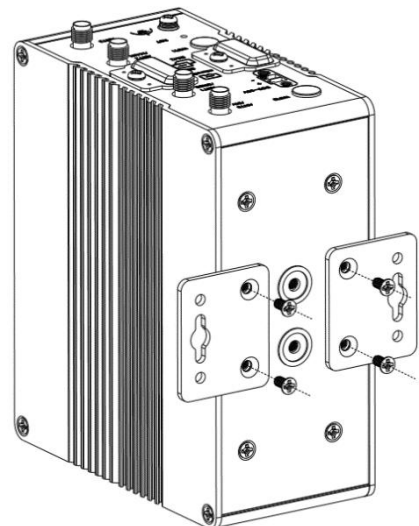

7. **Grounding the Device.** Grounding will help to prevent the noise effect due to electromagnetic interference (EMI). Connect the device to the site ground wire by the grounding screw before powering on.

Login to the Device

1. Connect the gateway’s Ethernet port to a PC with a standard Ethernet cable.
2. Before logging in, manually configure the PC with a static IP address on the same subnet as the gateway address, click and configure "Use the following IP address".

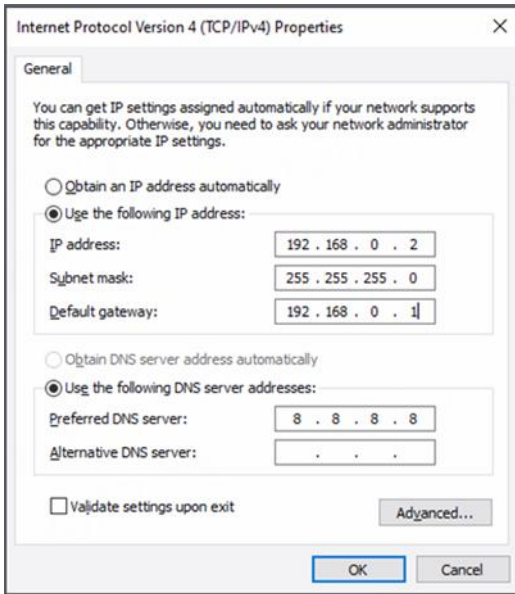

3. To enter the gateway's web interface, type <http://192.168.0.1> into the URL field of your Internet browser.
4. Use login information shown in the product label when prompted for authentication.



5. After logging in, the home page of the web interface is displayed, then you can view system information and perform configuration on the device.

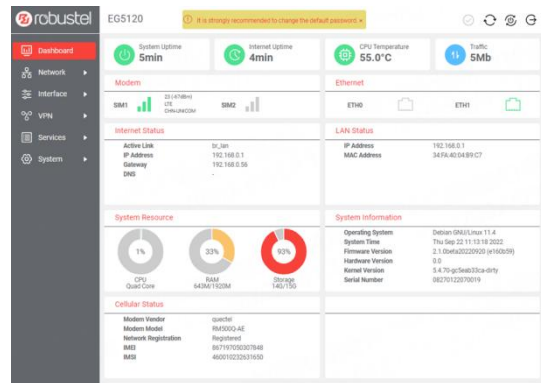

6. The automatic APN selection is ON by default, if need to specify your own APN, please go to the menu **Interface->Cellular->Advanced Cellular Setting->General Settings** to finish the specific setting.

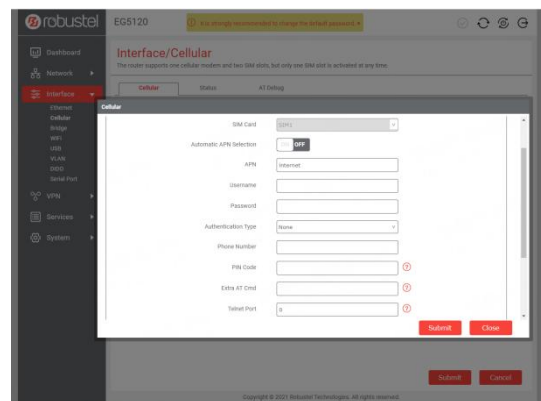

7. For more configuration details please refer to **RT104_SM_RobustOS Pro Software Manual**. (END)