

EV8100

Hardware Manual

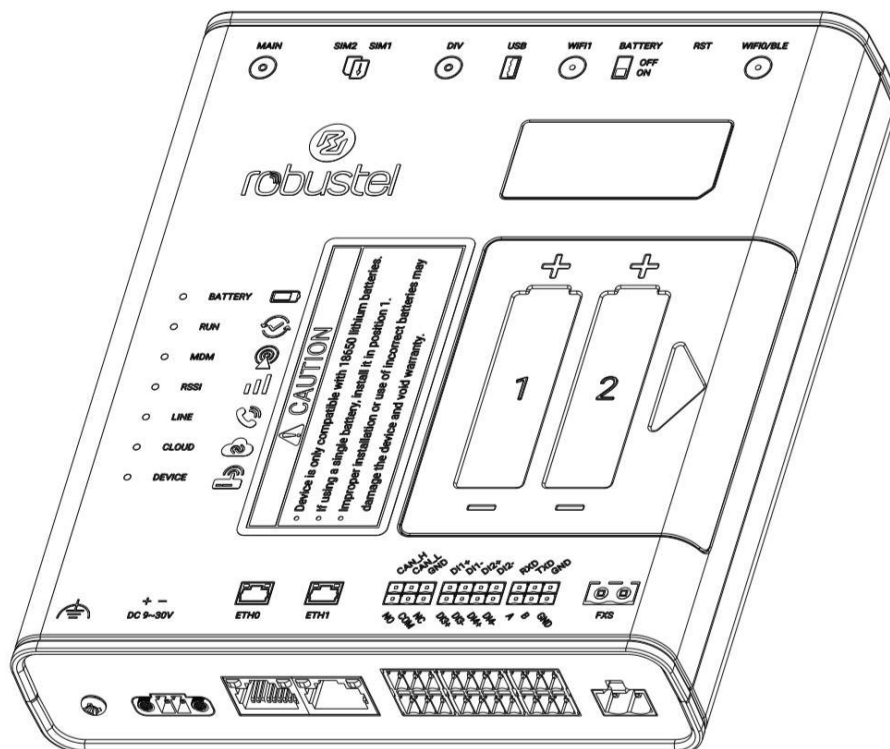

Version: 1.0.1

Date: May 22, 2024

Regulatory and Type Approval Information

Table 1: Toxic or Hazardous Substances or Elements with Defined Concentration Limits

Name of the Part	Hazardous Substances									
	(Pb)	(Hg)	(Cd)	(Cr(VI))	(PBB)	(PBDE)	(DEHP)	(BBP)	(DBP)	(DIBP)
Metal parts	X	o	o	o	-	-	-	-	-	-
Circuit modules	o	o	o	o	o	o	o	o	o	o
Cables and cable assemblies	o	o	o	o	o	o	o	o	o	o
Plastic and polymeric parts	o	o	o	o	o	o	o	o	o	o

o:
Indicates that this toxic or hazardous substance contained in all of the homogeneous materials for this part is below the limit requirement in RoHS2.0.

X:
Indicates that this toxic or hazardous substance contained in at least one of the homogeneous materials for this part *might exceed* the limit requirement in RoHS2.0.

-:
Indicates that it does not contain the toxic or hazardous substance.

Note: Excessive lead can be exempted.
1.Copper alloy containing up to 4 % lead by weight (RoHS Exemption 6(c)).
2.Electrical and electronic components containing lead in a glass or ceramic other than dielectric ceramic in capacitors, e.g. piezoelectronic devices, or in a glass or ceramic matrix compound (ROHS Exemption7(c)- I).

Radio Specifications for Europe

Model: EV8100-B-4L-A06GL

RF technologies	2G, 3G, 4G, Wi-Fi*, BLE*
Cellular Frequency	4G: LTE FDD: B1/B3/B5/B7/B8/B20/B28 LTE TDD: B38/B40/B41 3G: WCDMA: B1/B5/B8 2G: GSM900/GSM1800
Wi-Fi Frequency*	2.4 GHz: 2.412 ~ 2.484 GHz 5 GHz: 5.150 ~ 5.725 GHz
BR/EDR, BLE Frequency*	2402 ~ 2480 MHz
Max RF power	33 dBm±2dB@GSM, 24 dBm+1/-3dB@WCDMA, 27 dBm±2dB@LTE, 18 dBm ±2 dB @2.4GHz Wi-Fi, 19 dBm ±2 dB@5GHz Wi-Fi, 8 dBm ±2 dB@Bluetooth

Radio Specifications for Europe

Model: EV8100-B-4L-A12EU

RF technologies	2G, 3G, 4G, Wi-Fi*, BLE*
Cellular Frequency	4G: LTE FDD: B1/B3/B7/B8/B20/B28 LTE TDD: B38/B40/B41 3G: WCDMA: B1/B8 2G: GSM900/DCS1800
Wi-Fi Frequency*	2.4 GHz: 2.412 ~ 2.484 GHz 5 GHz: 5.150 ~ 5.725 GHz
BR/EDR, BLE Frequency*	2402 ~ 2480 MHz
Max RF power	33 dBm±2dB@GSM, 24 dBm+1/-3dB@WCDMA, 23 dBm±2dB@LTE, 17 dBm ±2 dB @2.4GHz Wi-Fi, 13 dBm ±2 dB@5GHz Wi-Fi, 4 dBm@Bluetooth

* *May vary on difference models.*

Note: The 5150 to 5350 MHz frequency range is restricted to indoor use only in.

電波法の規定により 5GHz 帯は屋内使用に限ります。

	AT	BE	BG	CH	CY	CZ	DE	DK
	EE	EL	ES	FI	FR	HR	HU	IE
	IS	IT	LI	LT	LU	LV	MT	NL
	NO	PL	PT	RO	SE	SI	SK	UK

Caution: The user is cautioned that changes or modifications not expressly approved by the party responsible for compliance could void the user's authority to operate the equipment.

This device contains licence-exempt transmitter(s)/receiver(s) that comply with Innovation, Science and Economic Development Canada's licence-exempt RSS(s) and Part 15 of the FCC Rules. Operation is subject to the following two conditions:

- (1) This device may not cause interference.
- (2) This device must accept any interference, including interference that may cause undesired operation of the device.

L'émetteur/récepteur exempt de licence contenu dans le présent appareil est conforme aux CNR d'Innovation, Sciences et Développement économique Canada applicables aux appareils radio exempts de licence. L'exploitation est autorisée aux deux conditions suivantes :

- (1) L'appareil ne doit pas produire de brouillage;
- (2) L'appareil doit accepter tout brouillage radioélectrique subi, même si le brouillage est susceptible d'en compromettre le fonctionnement.

Note: This equipment has been tested and found to comply with the limits for a Class B digital device, pursuant to Part 15 of the FCC Rules. These limits are designed to provide reasonable protection against harmful interference in a residential installation. This equipment generates, uses and can radiate radio frequency energy and, if not installed and used in accordance with the instructions, may cause harmful interference to radio communications. However, there is no guarantee that interference will not occur in a particular installation.

If this equipment does cause harmful interference to radio or television reception, which can be determined by turning the equipment off and on, the user is encouraged to try to correct the interference by one or more of the following measures:

- Reorient or relocate the receiving antenna.
- Increase the separation between the equipment and receiver.
- Connect the equipment into an outlet on a circuit different from that to which the receiver is connected.
- Consult the dealer or an experienced radio/TV technician for help.

FCC& IC Radiation Exposure Statement

This equipment complies with FCC and Canada radiation exposure limits set forth for an uncontrolled environment. This equipment should be installed and operated with a minimum distance of 20cm between the radiator and your body.

This transmitter must not be co-located or operating in conjunction with any other antenna or transmitter.

Déclaration d'IC sur l'exposition aux radiations

Cet équipement est conforme aux limites d'exposition aux radiations définies par le Canada pour des environnements non contrôlés. Cet équipement doit être installé et utilisé à une distance minimum de 20 cm entre l'antenne et votre corps.

Cet émetteur ne doit pas être installé au même endroit ni utilisé avec une autre antenne ou un autre émetteur.

Simplified EU & UK Declaration of Conformity

We, Guangzhou Robustel Co., Ltd. are located at 501, Building #2, 63 Yongan Road, Huangpu District, Guangzhou, China, declare that this radio equipment complies with EU Radio Equipment Directive (RED) 2014/53/EU, Low Voltage Directive (LVD) 2014/35/EU, EMC Directive 2014/30/EU, UK Radio Equipment Regulations 2017, EMC Regulations 2016, Electrical Equipment (Safety) Regulations 2016. The full text of the EU& UK DoC is available at the following internet address:

www.robustel.com/certifications/

Safety Information

General

- The router generates radio frequency (RF) power. When using the router, care must be taken on safety issues related to RF interference as well as regulations of RF equipment.
- Do not use your router in aircraft, hospitals, petrol stations or in places where using cellular products is prohibited.
- Be sure that the router will not be interfering with nearby equipment. For example: pacemakers or medical equipment. The antenna of the router should be away from computers, office equipment, home appliance, etc.
- An external antenna must be connected to the router for proper operation. Only uses approved antenna with the router. Please contact authorized distributor on finding an approved antenna.

RF Exposure

- This device meets the official requirements for exposure to radio waves. This device is designed and manufactured not to exceed the emission limits for exposure to radio frequency (RF) energy set by authorized agencies.

- The device must be used with a minimum separation of 20 cm from a person’s body to ensure compliance with RF exposure guidelines. Failure to observe these instructions could result in your RF exposure exceeding the applicable limits.

Note: Some airlines may permit the use of cellular phones while the aircraft is on the ground and the door is open. Router may be used at this time.



The symbol indicates that the product should not be mixed with general household waste but must be sent to separate collection facilities for recovery and recycling.



The symbol indicates that the product meets the requirements of the applicable EU directives.



The symbol indicates that the product meets the requirements of the relevant UK legislation.

⚠WARNING:

This product can expose you to chemicals including Lead, known to the State of California to cause cancer and birth defects or other reproductive harm. For more information go to www.P65Warnings.ca.gov.

Related download link

Find more product documents or tools at:
www.robustel.com/documentation/

Technical Support

Tel: 400-987-3791
 Email: support@robustel.com
 Web: www.robustel.com

Document History

Updates between document versions are cumulative. Therefore, the latest document version contains all updates made to previous versions.









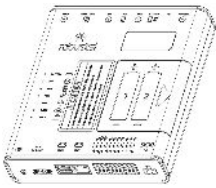

Date	Document Version	Change Description
Oct. 18, 2023	1.0.0	Initial release.
May 22, 2024	1.0.1	Added battery warnings and modified accessory information. Add the description of frequency bands for different models.

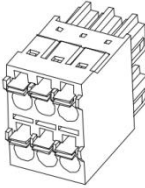
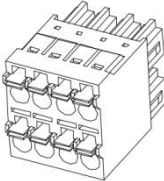
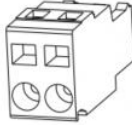
Overview

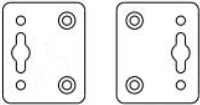
EV8100 is an advanced elevator voice gateway that supports voice transmission over VoIP and VoLTE, enabling seamless communication between a cellular network and the elevator's intercom system, with latest Linux Debian bullseye based router OS with enhanced cybersecurity, advanced GUI and a myriad of software features.

Package Checklist

Before commencing installation ensure your package has the following components:

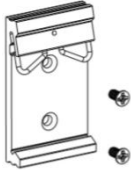
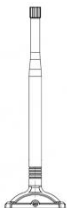
<p>Device</p> 	<p>2PIN Terminal Block with Lock</p> 	<p>3x2PIN Terminal Block</p> 	<p>4x2PIN Terminal Block</p> 	<p>2PIN 5.08mm Terminal Block</p> 
<p>RCMS Card</p> 	<p>Quick Start Guide Card</p> 	<p>Mounting Kit</p> 	<p>SIM Card Sticker</p> 	<p>Caution Card</p> 
<p>Magnet Button (Optional)</p> 	<p>Ethernet Cable (Optional)</p> 	<p>Power Supply (Optional)</p> 	<p>Cellular Antenna (Optional)</p> 	<p>Mounting Kit (Optional)</p> 
<p>Wi-Fi Antenna (Optional)</p> 				

Note: The accessories could be different on specific order.

Panel Layout

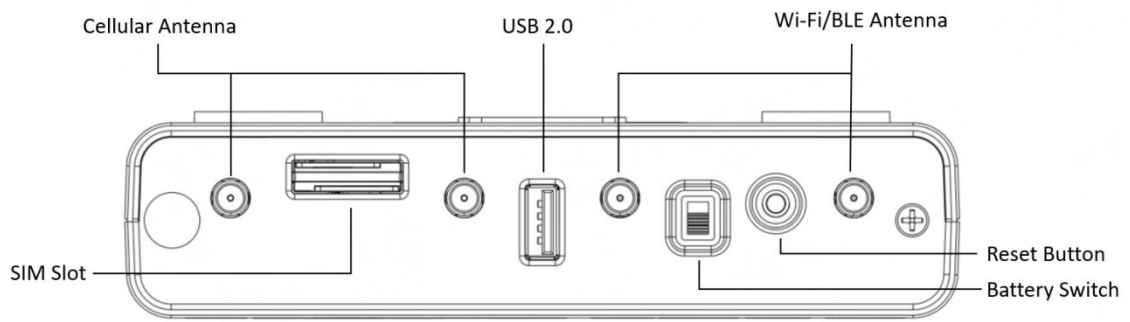

Top View

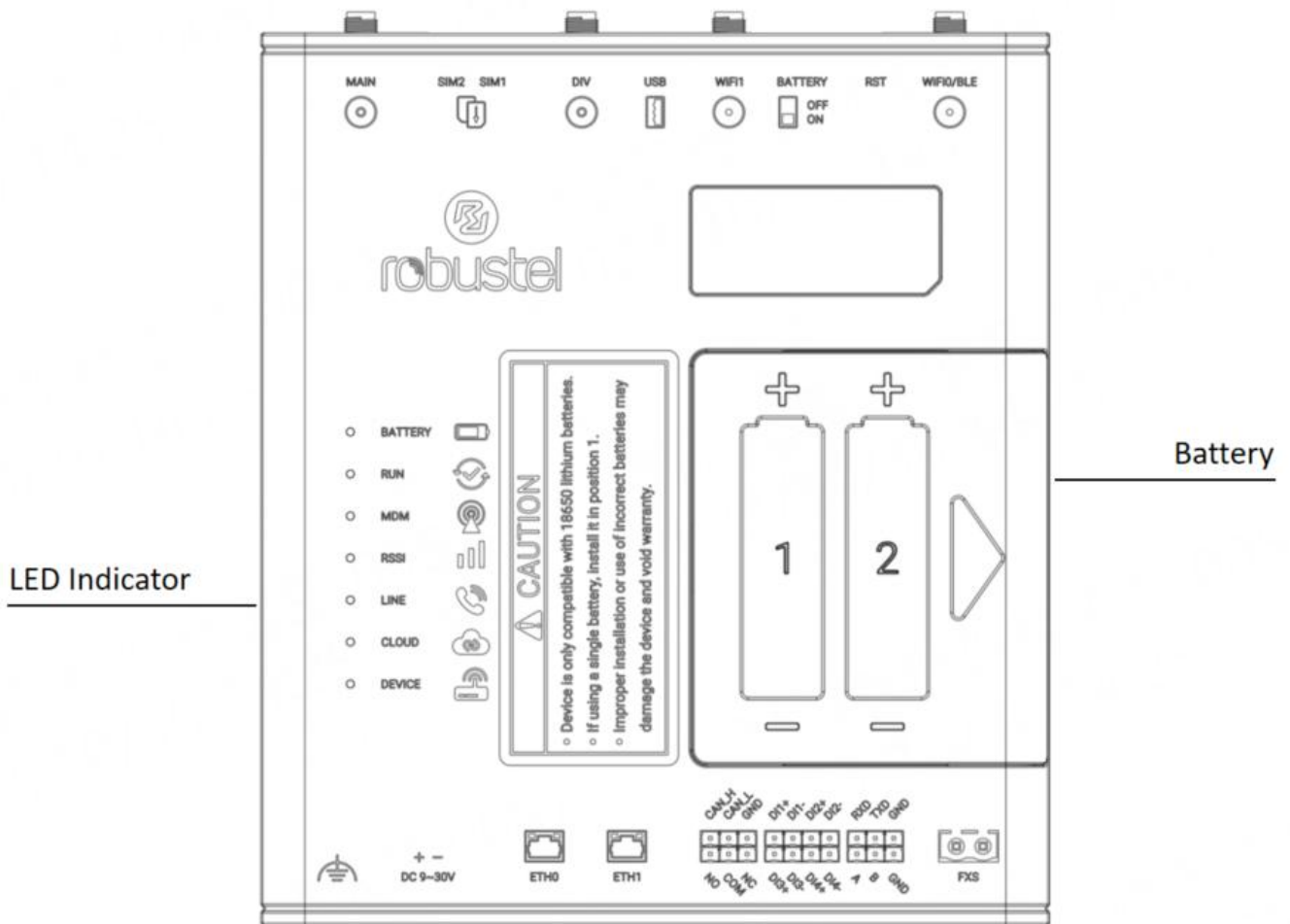

Front View

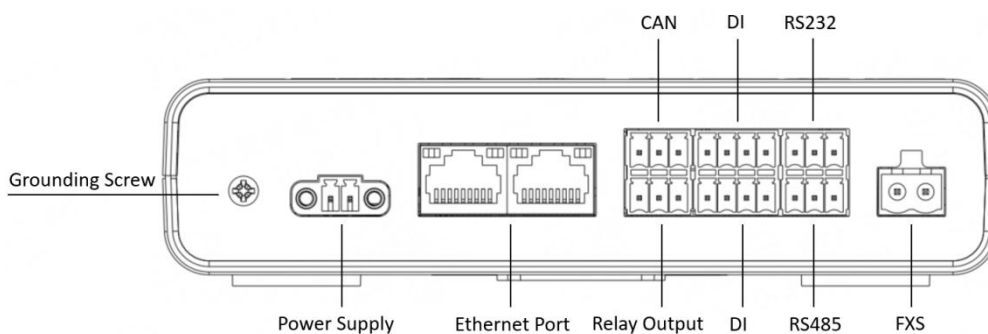

Bottom View

Interface Descriptions

1. Serial Ports.

Name	Description	
CANL	For transmitting low-level signals	
CANH	For transmitting high-level signals	
GND	Ground	
Name	RS232 Mode	RS485 Mode
TXD/A	data sending	RS485_A
RXD/B	data receiving	RS485_B
GND	Ground	Ground

2. Ethernet Ports. Two Ethernet ports, both of them could be configured as WAN or LAN.

LED	Description	
Activity	On, blinking	Transmitting data
	Off	No activity
	Link	
Link	Off	Link off
	On	Link on

3. Reset Button.

Function	Operation
Reboot	Press and hold the RST button for 2~5 seconds under the operating status.
Restore to default configuration	Press and hold the RST button for 5 ~10 seconds under the operating status. The RUN light flashes quickly, and then release the RST button, and the device will restore to the default configuration.
Restore to factory configuration	Once the operation of restoring the default configuration is performed twice within one minute, the device will restore to the factory default settings.

4. Digital Input and Relay Output. Four sets of digital inputs and a set of relay output.

Name	Type	Description
DI1+	Digital I/O	Digital Input positive
DI1-		Digital Input negative
DI2+		Digital Input positive
DI2-		Digital Input negative
DI3+		Digital Input positive
DI3-		Digital Input negative
DI4+		Digital Input positive
DI4-		Digital Input negative
NC	Relay Output	Normally Closed
COM		Common
NO		Normally Open

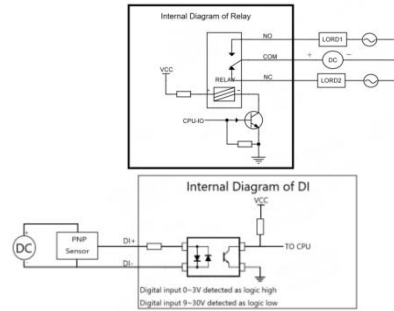

Note: When the relay is off, NC is connected to COM, and NO is disconnected. The external power supply input voltage range is DC 5-48V, with a maximum load current of 300mA.

5. LED Indicators.

LED	Description	
RUN	On, solid	Gateway system is initializing
	On,blinking	Gateway starts operating
	Off	Gateway is powered off
Line	Color	SIP: Green, VoLTE: Yellow, Other: Red
	On	In a call
	On,blinking	On-hook
	Off	Dialing/Incoming call
MDM	Color	2G: Red, 3G: Yellow, 4G: Green
	On, blinking	Link connection is working
	Off	Link connection is not working
Signal	Green	Strong signal
	Yellow	Medium signal
	Red	Weak or no signal
Cloud	On, solid	Connected successfully
	On,blinking	In communication
	Off	Disconnected
Device	On, solid	Connected successfully
	On,blinking	In communication
	Off	Disconnected
Battery	On	Powered by Battery
	On,blinking	1. Battery Powered: Low battery level 2. AC Powered: Battery malfunction or Battery anomaly
	Off	Non-battery power supply

6. FXS

Name	Description
TIP	Connect to the RING lead of the subscriber loop.
RING	Connect to the TIP lead of the subscriber loop.

Lithium-ion Battery Instructions

1. Device is only compatible with 18650 lithium batteries.
2. If using a single battery, install it in position 1.
3. Improper installation or use of incorrect batteries may damage the device and void warranty.

Caution: Risk of fire or explosion if the battery is replaced by an incorrect type.

Hardware Installation

1. **SIM Card Installation.** Insert the SIM cards into the device and paste SIM card cover sticker if needed.

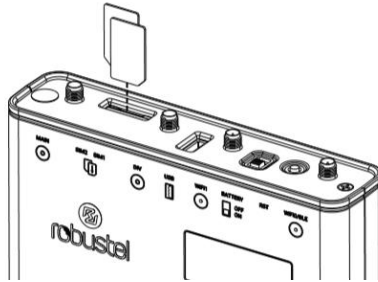

2. **Antenna Installation.** Rotate the antenna into the antenna connector accordingly.

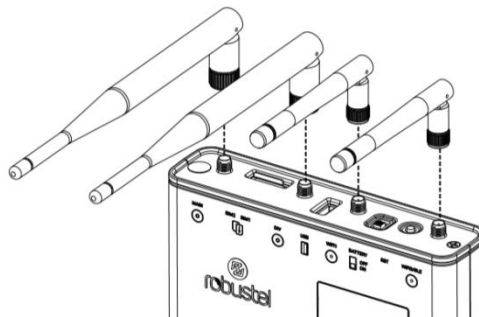

3. **Terminal Block Installation.** Insert the 2x3PIN and 2x4PIN terminal blocks into the interfaces connector, then can connect the devices or sensors to the gateway with wires via corresponding interfaces e.g. RS232, RS485, DIDO, CAN, FXS...

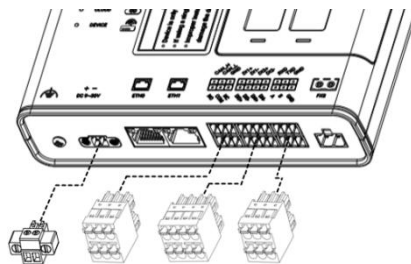

4. **Power Supply installation.** Insert the power supply cord into the corresponding terminal block if needed, then insert the terminal block into the power connector.

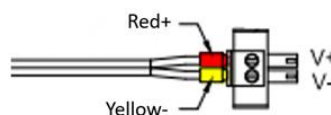

5. **DIN Rail Mounting.** Use 2 M3 screws to fix the DIN rail to the device, then hang the DIN rail on the mounting bracket.

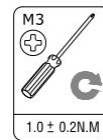
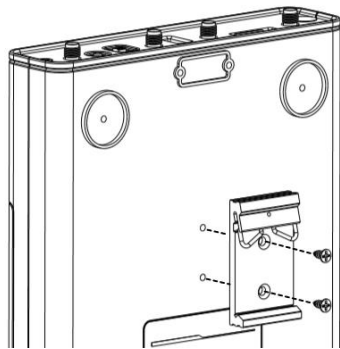

6. **Wall Mounting.** Use 4 M3 screws to fix the Wall mounting to the device.

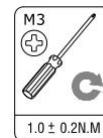
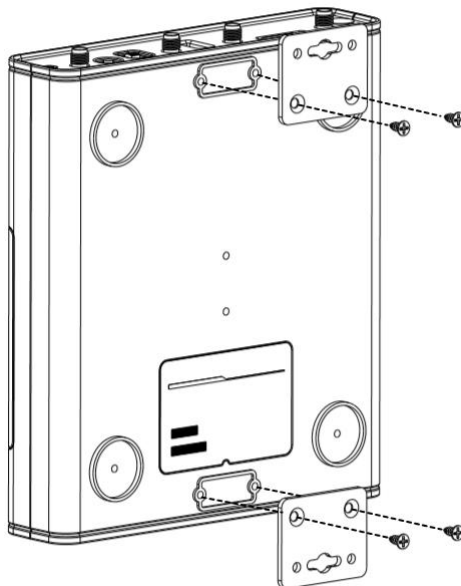

7. **Magnetic Mounting.** Use 4 magnet buttons to attach in the corresponding positions behind the device with screws.

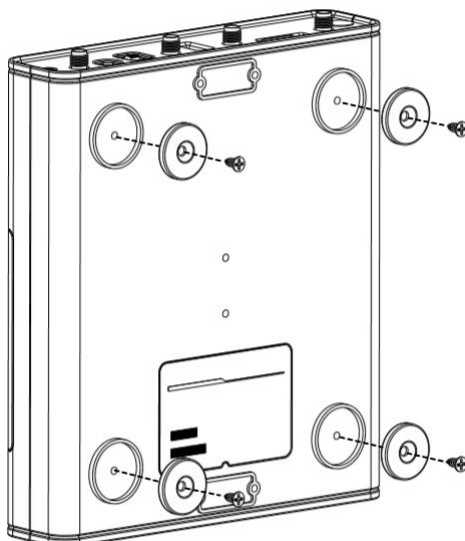

8. **Batteries Installation.** Open the battery cover, insert the 18650 lithium battery starting from the positive end into the designated compartment, ensuring proper alignment, and close the cover.

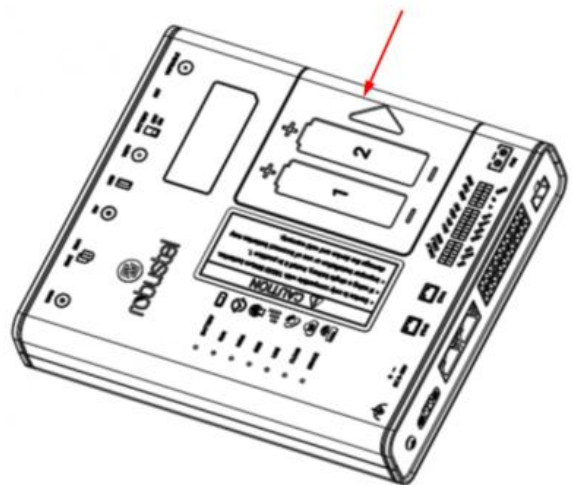
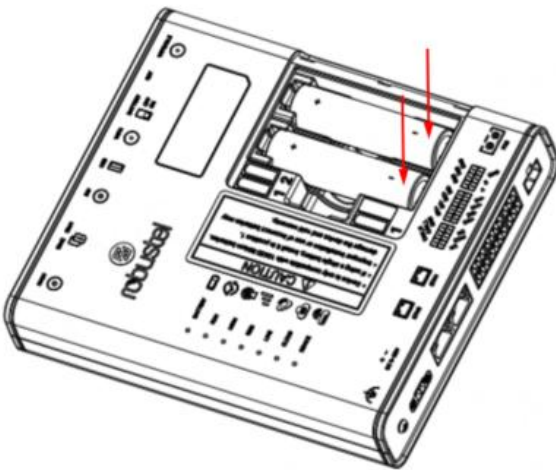
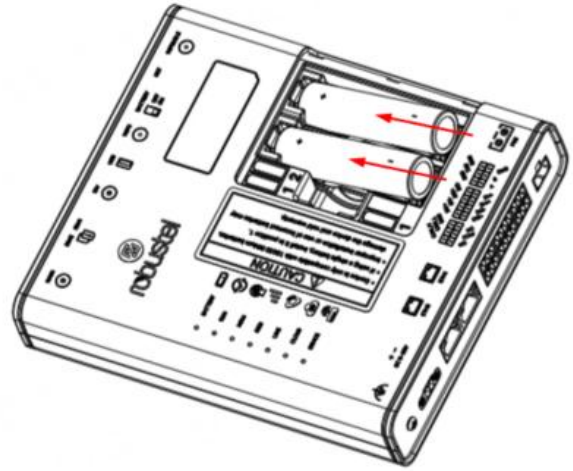
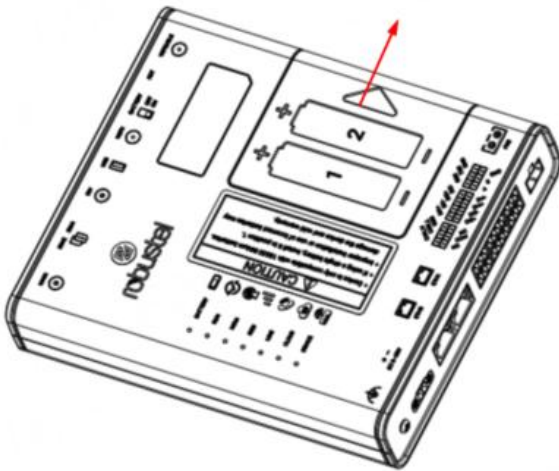

9. **Batteries Removal.** Open the battery cover, pull out the battery starting from the negative end from the designated compartment, and then close the cover.

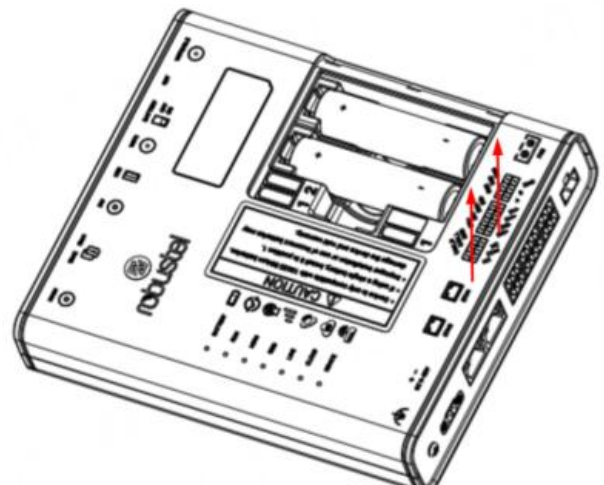
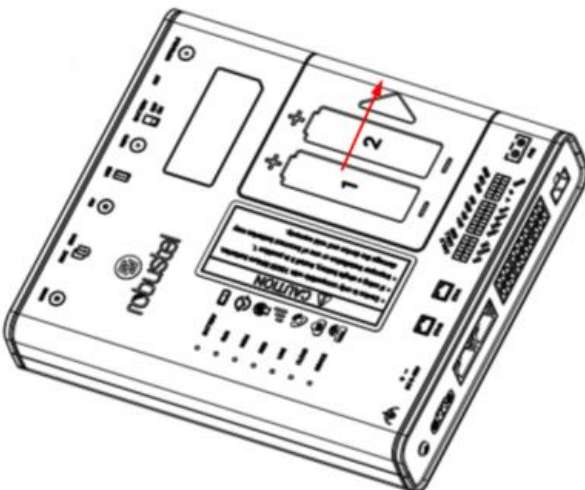

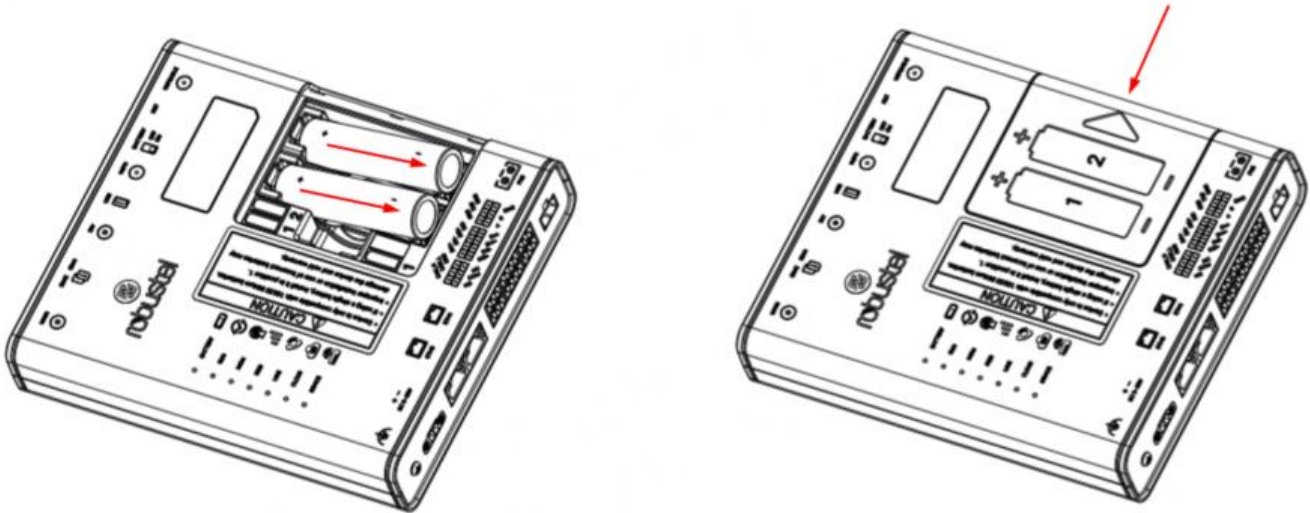

10. **Grounding the Device.** Grounding will help to prevent the noise effect due to electromagnetic interference (EMI). Connect the device to the site ground wire by the grounding screw before powering on.

Login to the Device

1. Connect the gateway’s Ethernet port to a PC with a standard Ethernet cable.
2. Before logging in, manually configure the PC with a static IP address on the same subnet as the gateway address, click and configure "Use the following IP address".

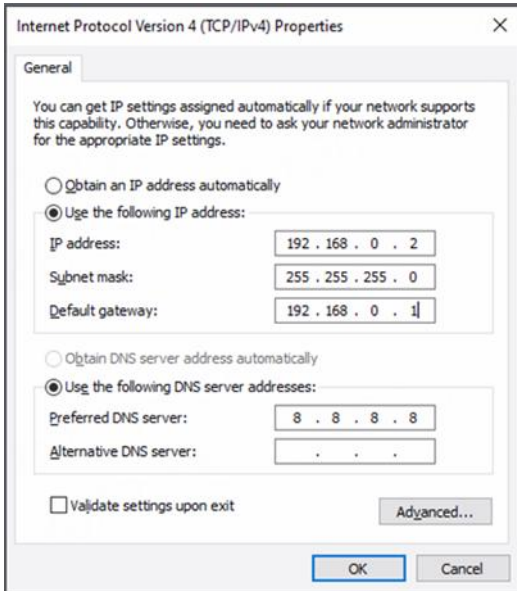

3. To enter the gateway's web interface, type <http://192.168.0.1> into the URL field of your Internet browser.
4. Use login information shown in the product label when prompted for authentication.



5. After logging in, the home page of the web interface is displayed, then you can view system information and perform configuration on the device.

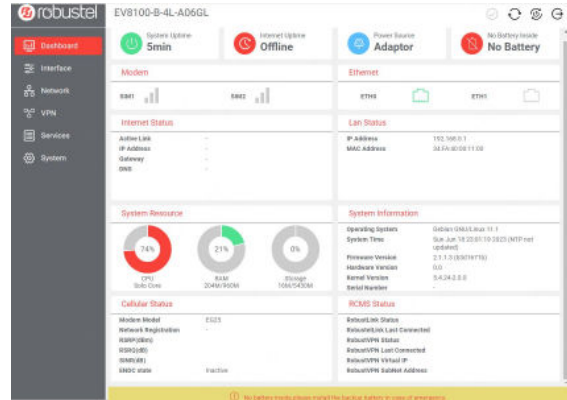

6. The automatic APN selection is ON by default, if need to specify your own APN, please go to the menu **Interface->Cellular->Advanced Cellular Setting->General Settings** to finish the specific setting.

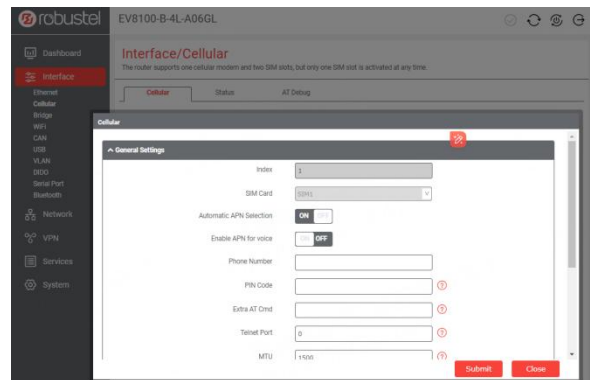

7. For more configuration details please refer to **RT104_SM_RobustOS Pro Software Manual**. (END)