



User Guide

GoRugged M1000 MP

Industrial Cellular Modem

1 RS-232 + 1 USB Host



About This Document

This document provides hardware information of the Robustel M1000 MP Modem, including introduction, installation and operation.

Copyright©2019 Guangzhou Robustel LTD

All rights reserved.

Trademarks and Permissions

robustel is the trademark of Guangzhou Robustel LTD. All other trademarks and trade names mentioned in this document are the property of their respective owners.

Disclaimer

No part of this document may be reproduced in any form without the written permission of the copyright owner. The contents of this document are subject to change without notice due to continued progress in methodology, design and manufacturing. Robustel shall have no liability for any error or damage of any kind resulting from the use of this document.

Technical Support

Tel: +86-20-29019902

Fax: +86-20-82321505

Email: support@robustel.com

Web: www.robustel.com

Important Notice

Due to the nature of wireless communications, transmission and reception of data can never be guaranteed. Data may be delayed, corrupted (i.e., have errors) or be totally lost. Although significant delays or losses of data are rare when wireless devices such as the modem is used in a normal manner with a well-constructed network, the modem should not be used in situations where failure to transmit or receive data could result in damage of any kind to the user or any other party, including but not limited to personal injury, death, or loss of property. Robustel accepts no responsibility for damages of any kind resulting from delays or errors in data transmitted or received using the modem, or for failure of the modem to transmit or receive such data.

Safety Precautions

General

- The modem generates radio frequency (RF) power. When you use the modem, care must be taken on safety issues related to RF interference as well as regulations of RF equipment.
- Do not use your modem in aircraft, hospitals, petrol stations or in places where using cellular products is prohibited.
- Be sure that the modem will not be interfering with nearby equipment such as pacemakers and medical equipment. The antenna of the modem should be kept away from computers, office equipment, home appliance, etc.
- An external antenna must be connected to the modem for proper operation. Only use approved antenna with the modem. Please contact authorized distributor to find an approved antenna.
- Always keep the antenna with minimum safety distance of 20 cm or more from human body. Do not put the antenna inside metallic box, containers, etc.
- RF exposure statements
 1. For mobile devices without co-location (the transmitting antenna is installed or located more than 20cm away from the body of user and nearby person)
- FCC RF Radiation Exposure Statement
 1. This Transmitter must not be co-located or operating in conjunction with any other antenna or transmitter.
 2. This equipment complies with FCC RF radiation exposure limits set forth for an uncontrolled environment. This equipment should be installed and operated with a minimum distance of 20 centimeters between the radiator and human body.

Note: Some airlines may permit the use of cellular phones while the aircraft is on the ground and the door is open. Modem may be used at this time.

Using the Modem in Vehicle

- Check for any regulation or law authorizing the use of cellular devices in vehicle in your country before installing the modem.
- The driver or operator of any vehicle should not operate the modem while driving.
- The device should be installed by qualified personnel. Consult your vehicle distributor for any possible interference of electronic parts by the modem.
- The modem should be connected to the vehicle's supply system by using a fuse-protected terminal in the vehicle's fuse box.
- Be careful when the modem is powered by the vehicle's main battery. The battery may be drained after extended period.

Protecting Your Modem

To ensure error-free usage, please install and operate your modem with care. Do remember the following:

- Do not expose the modem to extreme conditions such as high humidity / rain, high temperature, direct sunlight, caustic / harsh chemicals, dust, or water.
- Do not try to disassemble or modify the modem. There is no user serviceable part inside and the warranty would be void.
- Do not drop, hit or shake the modem. Do not use the modem under extreme vibrating conditions.
- Do not pull the antenna or power supply cable. Attach/detach by holding the connector.
- Connect the modem only according to the instruction manual. Failure to do it will void the warranty.
- In case of problem, please contact authorized distributor.

Regulatory and Type Approval Information

Table 1: Directives



2011/65/EU	The European RoHS2.0 2011/65/EU Directive was issued by the European parliament and the European Council on 1 July 2011 on the restriction of the use of certain Hazardous substances in electrical and electronic equipment.	
2012/19/EU	The European WEEE 2012/19/EU Directive was issued by the European parliament and the European Council on 24 July 2012 on waste electrical and electronic equipment.	
2013/56/EU	The European 2013/56/EU Directive is a battery Directive which published in the EU official gazette on 10 December 2013. The button battery used in this product conforms to the standard of 2013/56/EU directive.	

Table 2: Standards of the electronic industry of the People's Republic of China

SJ/T 11363-2006	<p>The electronic industry standard of the People's Republic of China SJ/T 11363-2006 "Requirements for Concentration Limits for Certain Toxic and Hazardous Substances in Electronic Information Products" issued by the ministry of information industry of the People's Republic of China on November 6, 2006, stipulates the maximum allowable concentration of toxic and hazardous substances in electronic information products.</p> <p>Please see Table 3 for an overview of toxic or hazardous substances or elements that might be contained in product parts in concentrations above the limits defined by SJ/T 11363-2006.</p>
SJ/T 11364-2014	<p>The electronic industry standard of the People's Republic of China SJ/T 11364-2014 "Labeling Requirements for Restricted Use of Hazardous Substances in Electronic and Electrical Products" issued by the ministry of Industry and information technology of the People's Republic of China on July 9, 2014, stipulates the Labeling requirements of hazardous substances in electronic and electrical products, environmental protection use time limit and whether it can be recycled. This standard is applicable to electronic and electrical products sold within the territory of the People's Republic of China, and can also be used for reference in the logistics process of electronic and electrical products.</p> <p>The orange logo below is used for Robustel products:</p> <div style="text-align: right;">  </div> <p>Indicates its warning attribute, that is, some hazardous substances are contained in the product. The "10" in the middle of the legend refers to the environment-friendly Use Period (EFUP) * of electronic information product, which is 10 years. It can be used safely during the environment-friendly Use Period. After the environmental protection period of use, it should enter the recycling system.</p> <p>*The term of environmental protection use of electronic information products refers to the term during which the toxic and hazardous substances or elements contained in electronic information products will not be leaked or mutated and cause serious pollution to the environment or serious damage to people and property under normal conditions of use.</p>

Table 3: Toxic or Hazardous Substances or Elements with Defined Concentration Limits

Name of the Part	Hazardous Substances									
	(Pb)	(Hg)	(Cd)	(Cr(VI))	(PBB)	(PBDE)	(DEHP)	(BBP)	(DBP)	(DIBP)
Metal parts	o	o	o	o	–	–	–	–	–	–
Circuit modules	o	o	o	o	o	o	o	o	o	o
Cables and cable assemblies	o	o	o	o	o	o	o	o	o	o
Plastic and polymeric parts	o	o	o	o	o	o	o	o	o	o

o:
Indicates that this toxic or hazardous substance contained in all of the homogeneous materials for this part is below the limit requirement in RoHS2.0.

X:
Indicates that this toxic or hazardous substance contained in at least one of the homogeneous materials for this part *might exceed* the limit requirement in RoHS2.0.

–:
Indicates that it does not contain the toxic or hazardous substance.

Document History

Updates between document versions are cumulative. Therefore, the latest document version contains all updates made to previous versions.

Date	Document Version	Change Description
Dec. 18, 2013	V1.0.0	Initial release
Jan. 4, 2015	V1.1.0	Updated information about: <ul style="list-style-type: none"> Package Contents SIM installation Power Supply
Mar. 19, 2015	V1.2.0	Updated information about: <ul style="list-style-type: none"> Safety Precautions Regulatory and Type Approval Information PIN Assignment LED Indicators Mount the Modem file format device pictures
May 13, 2015	V1.2.1	Updated information about: <ul style="list-style-type: none"> Regulatory and Type Approval Information picture for single-antenna device LED Indicators
Oct. 7, 2015	V1.2.2	Updated information about: <ul style="list-style-type: none"> cover image Package Contents antenna specifications
Nov. 8, 2015	v.1.2.3	Updated logo
Nov. 11, 2016	v.1.2.4	Updated information in 2.9 Power Supply Updated figures with new logo
Jan. 20, 2017	v.1.2.5	Changed Tel number to +86-20-29019902 Changed CD information in Chapter 1.2
Jun. 6, 2017	v.1.2.7	Corrected the description of cellular interface in Chapter 1.3
Aug. 11, 2017	v.2.0.0	Updated the document template
Apr. 09, 2017	v.2.0.1	<ul style="list-style-type: none"> Updated ordering information Updated serial port information Updated indicators' status Updated PIN assignment Added AT command to dial model via USB port Other minor editorial changes
Jun. 12, 2018	v.2.0.2	Changed related information of antenna
Jun. 13, 2018	v.2.0.3	Changed the image of device on the cover and chapter 2.2
Jun. 30, 2018	v.2.0.4	Revised the company name
Nov. 26, 2018	v.2.0.6	Delete the invalid download link of Command Set

Jan. 30, 2019	v.2.0.7	Revised the certifications
Dec. 18, 2019	v.2.0.8	Revised the Regulatory and Type Approval Information Add product models and update corresponding information

Contents

Contents	9
Chapter 1 Product Overview	10
1.1 Key Features	10
1.2 Package Contents.....	10
1.3 Specifications.....	12
1.4 Dimensions	13
Hardware Installation	14
2.1 PIN Assignment.....	14
2.2 LED Indicators	15
2.3 USB Interface	16
2.4 Insert or Remove SIM Card	17
2.5 Attach External Antenna (SMA Type).....	18
2.6 Mount the Modem	18
2.7 Connect the Modem to External Device.....	19
2.8 Power Supply	20
Chapter 2 Modem Operation	21
3.1 AT Command Set	21
3.1.1 Start SecureCRT	21
3.1.2 AT Command Examples	23
3.2 Using Short Message Service.....	23
3.2.1 Sending a Short Message.....	24
3.2.2 Reading a Short Message	24
3.2.3 Deleting a Short Message.....	25
3.3 GPRS Connection	25
3.3.1 Overview.....	25
3.3.2 Windows GPRS Access.....	26
Chapter 3 Appendix	37
4.1 GSM Alphabet.....	37
4.2 Troubleshooting.....	40
4.2.1 What should I do if the LED indicator doesn't work?.....	40
4.2.2 What should I do if the modem always keeps restarting?	40
4.2.3 What should I do if the serial port connection fails?.....	40
4.2.4 What should I do if the modem receives the "No Carrier" message?	41
4.3 Glossary	42

Chapter 1 Product Overview

1.1 Key Features

The Robustel Industrial Cellular Modem M1000 MP is a compact design cellular modem based on GSM/GPRS/EDGE/UMTS/HSDPA/HSUPA/HSPA+/LTE Cat 1 networks. It offers the state-of-the-art 2G/3G/4G connectivity for machine to machine (M2M) applications, providing users with reliable data transmission.

- Control via AT commands (Hayes 3GPP TS 27.007 and 27.005)
- Connecting TCP/IP and sending SMS via AT commands
- Supporting 1 x RS-232
- Supporting 1 x mini USB 2.0 high speed interface
- -40 to +85 °C extended operating temperature
- Robust industrial design (6 to 36V DC, desktop or wall mounting or DIN rail mounting)

1.2 Package Contents

Before installing your M1000 MP Modem, verify the kit contents as following.

Note: The following pictures are for illustration purposes only, not based on their actual sizes.

- 1 x Robustel M1000 MP Industrial Cellular Modem



Single-antenna

- 1 x 2-pin 3.5 mm male terminal block for power supply



- 1 x *Quick Start Guide* with download link of other documents or tools

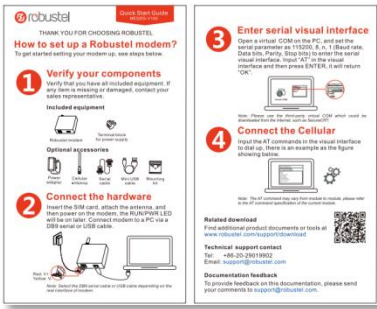

Note: If any of the above items is missing or damaged, please contact your Robustel sales representative.

Optional Accessories (sold separately):

- 3G/4G SMA cellular antenna (stubby/magnet optional)

Stubby antenna



Magnet antenna



- Wall mounting kit



- 35 mm DIN rail mounting kit

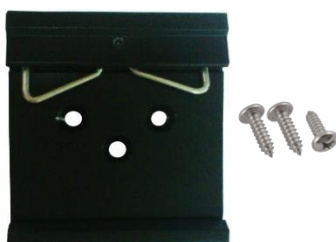

- RS-232 serial cable (DB9 male to DB9 female)



- Mini USB cable



- AC/DC power adapter (12V DC, 1.0 A; EU/US/UK/AU plug optional)



1.3 Specifications

Cellular Interface

- Number of antennas: 1 (MAIN)
- Connector: SMA female
- SIM: 1 (3.0 V & 1.8 V)
- Standards: GSM/GPRS/EDGE/UMTS/HSDPA/HSUPA/HSPA+/LTE Cat 1

Serial Interface

- Number of ports: 1 x RS-232
- Connector: DB9 female
- Baud rate: 1200 bps to 115200 bps
- RS-232: Rx/D, Tx/D, RTS, CTS, GND

USB Interface

- Number of ports: 1 x mini USB

- Connector: Mini female
- Speed: 2.0 high speed up to 480 Mbit/s

Others

- Reset button: 1 x RST
- LED indicators: 1 x POWER + 1 x STATUS

Power Supply and Consumption

- Connector: 2-pin 3.5 mm female socket
- Input voltage: 6 to 36V DC
- Power consumption: Idle: 50 to 60 mA@12 V
Data link: 100 to 200 mA (peak) @12 V

Physical Characteristics

- Ingress protection: IP30
- Housing & Weight: Plastic, 90 g
- Dimensions: 85 x 75 x 28.5 mm
- Installations: Desktop, wall mounting and 35 mm DIN rail mounting

1.4 Dimensions

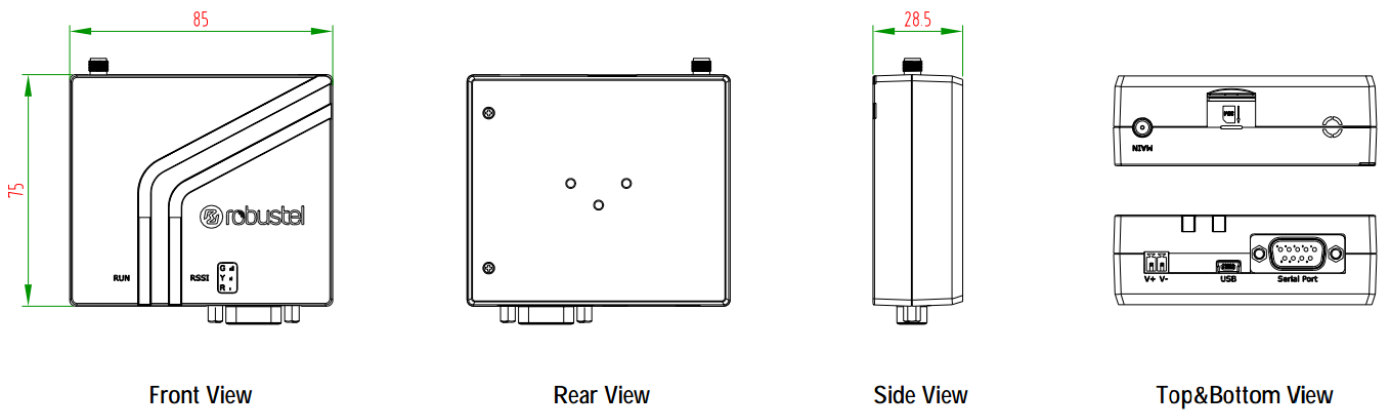

Hardware Installation

2.1 PIN Assignment

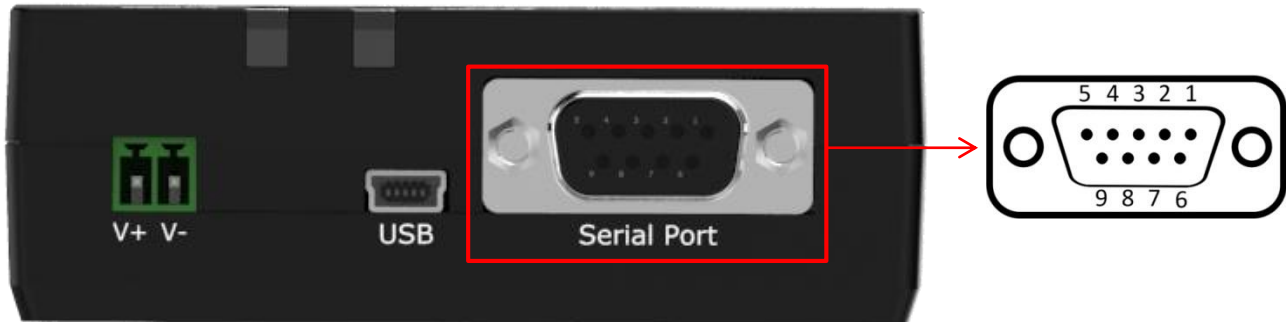

PIN	RS-232	Terminal block	Direction
1	DCD	--	M1000 MP → Device
2	RXD	RXD	M1000 MP → Device
3	TXD	TXD	M1000 MP ← Device
4	DTR	DT	M1000 MP ← Device
5	GND	GND x 2	--
6	DSR	--	M1000 MP → Device
7	RTS	RTS	M1000 MP ← Device
8	CTS	CTS	M1000 MP → Device
9	RI	DR	M1000 MP → Device

2.2 LED Indicators

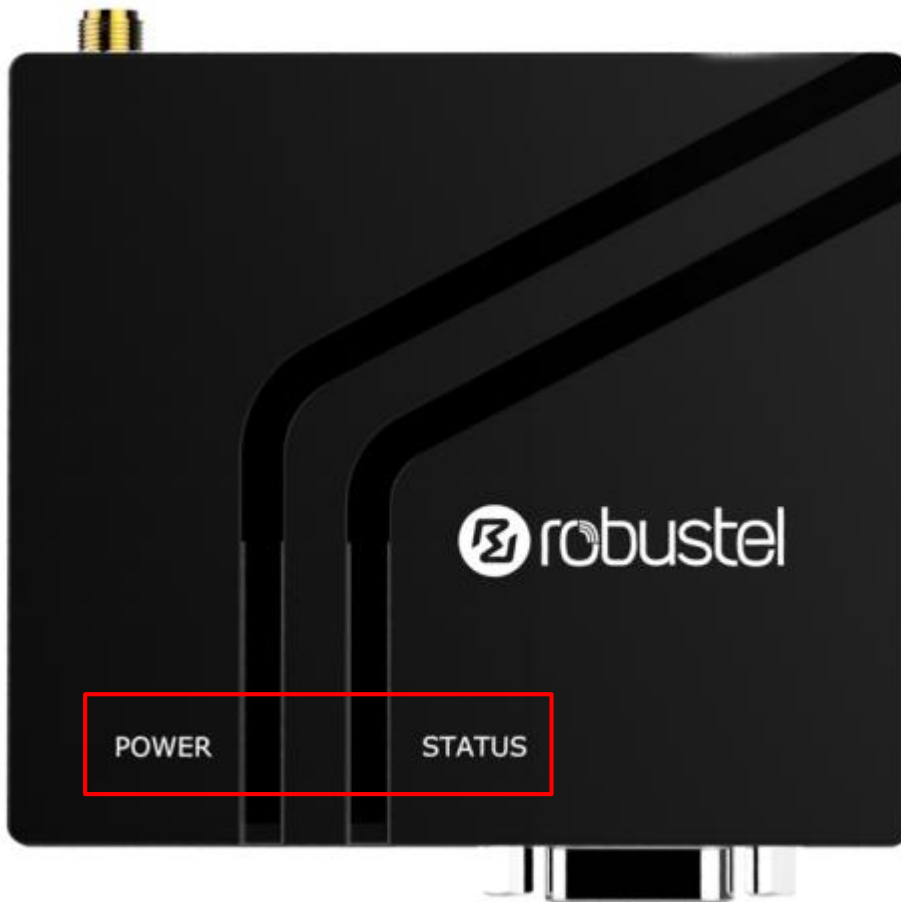

Name	Color	Status	Description
POWER	Green	On, solid	Modem is powered on.
		Off	Modem is powered off.
STATUS	Green	On, 0.5 sec blink (for single-antenna)	The current network is connected. Note: Only available for the 3G/4G module, and the indicator will never be lit if the current 3G/4G module does not support it.
		On, 3 sec blink	The current network is disconnected. Note: Only available for the 3G/4G module, and the indicator will never be lit if the current 3G/4G module does not support it.

2.3 USB Interface

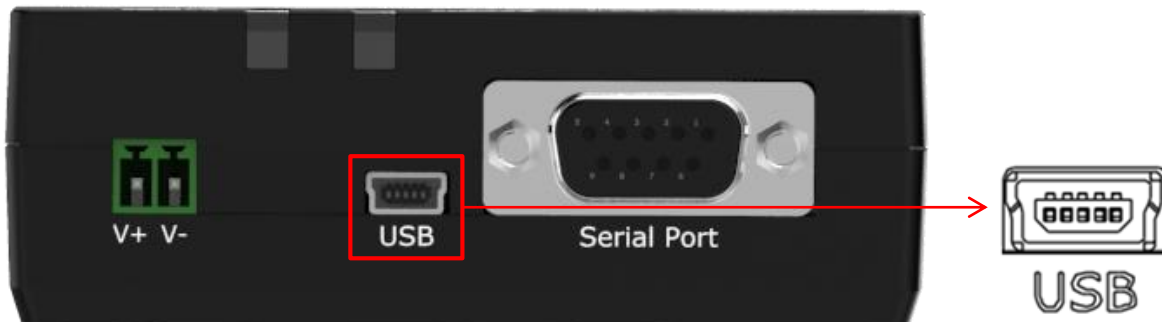

Function	Operation
Data transmission	Connect an USB cable to the mini USB connector at the bottom of the M1000 MP Modem, and connect the other end of the cable to external communication equipment.
Power supply	Connect an USB cable to the mini USB connector at the bottom of the M1000 MP Modem, and connect the other end of the cable to external power supply equipment.

Note: Normally, the output current and voltage from the PC's USB interface are 0.5 A and 5 V. When you use the USB interface to send and receive data, you should use the power interface of the device to supply power. When you use the USB interface for data transmission and power supply simultaneously, please make sure that the output current and voltage from the USB interface are at least 1 A and 5 V.

2.4 Insert or Remove SIM Card

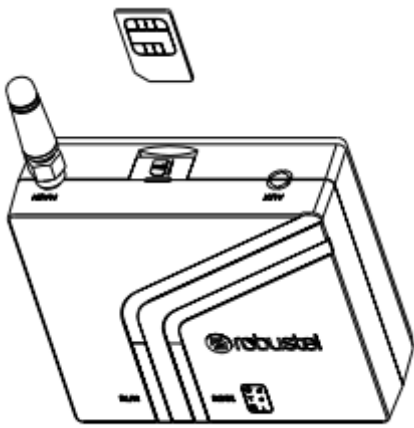

Please ensure to insert the SIM card before starting. If the PIN of the SIM card is unlocked, and if the corresponding PIN code is incorrect at the time of device configuration, the SIM card is unavailable.

Insert or remove the SIM card as shown in the following steps.

- **Insert SIM card**

1. Make sure the modem is powered off.
2. To insert SIM card, press the card with finger until you hear a click.

- **Remove SIM card**

1. Make sure the modem is powered off.
2. To remove SIM card, press the card with finger until it pops out, and then take out the card.

Note:

1. Recommended torque for inserting is 0.5 N.m, and the maximum allowed is 0.7 N.m.
2. Use the specific card when the device is working in extreme temperature (temperature exceeding 40 °C), because the regular card for long-time working in harsh environment will be disconnected frequently.
3. Do not touch the metal of the card surface in case information in the card will lose or be destroyed.
4. Do not bend or scratch the card.
5. Keep the card away from electricity and magnetism.
6. Make sure the modem is powered off before inserting or removing the card.

2.5 Attach External Antenna (SMA Type)

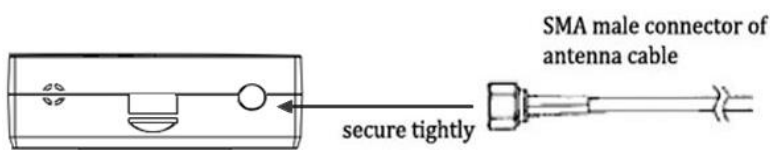
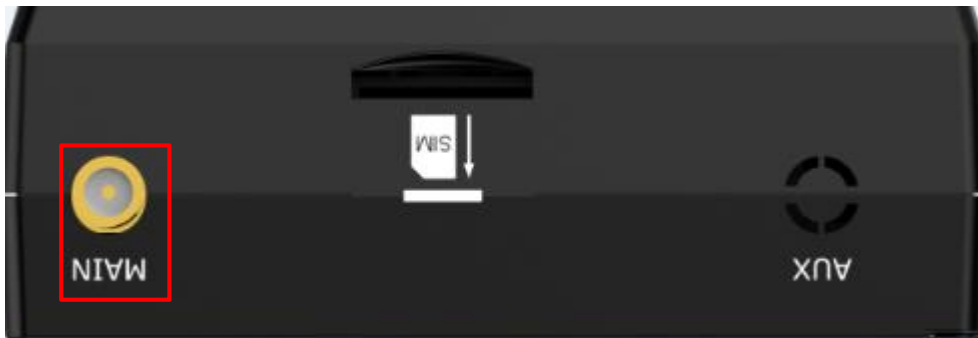

Attach an external SMA antenna to the modem’s antenna connector and twist tightly. Make sure the antenna is within the correct frequency range provided by the ISP and with 50 Ohm impedance.

Note: Recommended torque for tightening is 0.35 N.m.

2.6 Mount the Modem

The modem can be placed on a desktop or mounted to a wall or a 35 mm DIN rail.

Two methods for mounting the modem

1. Wall mounting (measured in mm)

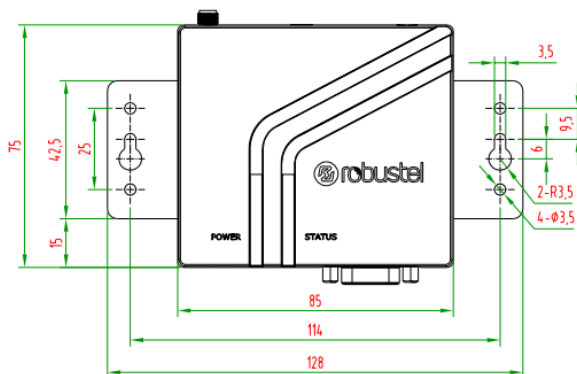

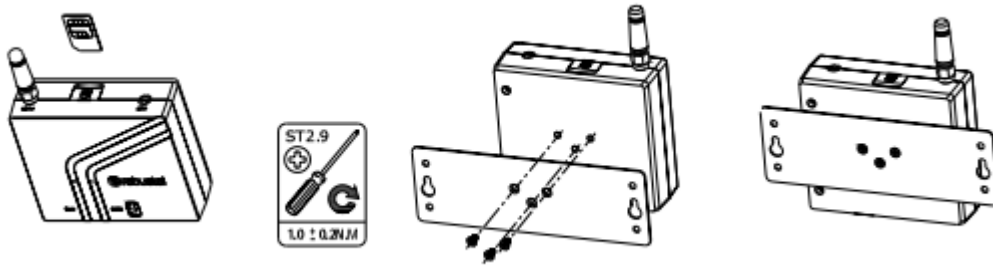

Use 3 pcs of ST2.9*6 pan head self-tapping Phillips screws to fix the wall mounting kit to the modem, and then use 2 pcs of M3 drywall screws to mount the modem associated with the wall mounting kit on the wall.

Note: Recommended torque for mounting is 1.0 N.m, and the maximum allowed is 1.2 N.m.

2. DIN rail mounting (measured in mm)

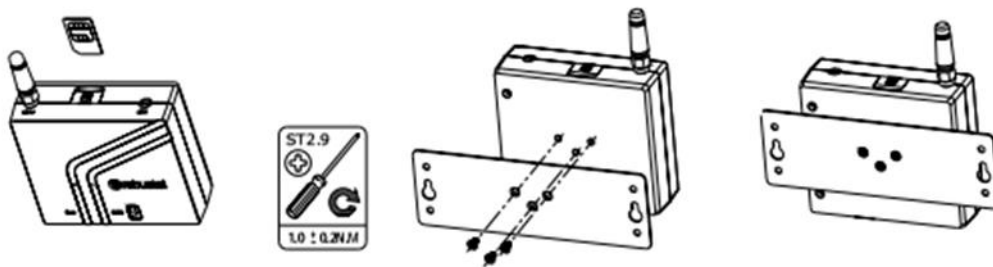
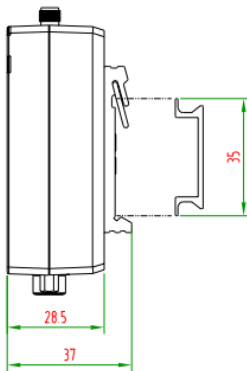

Use 3 pcs of ST2.9*8 pan head self-tapping Phillips screws to fix the DIN rail to the modem, and then hang the DIN rail on the mounting bracket. It is necessary to choose a standard bracket.

Note: Recommended torque for mounting is 1.0 N.m, and the maximum allowed is 1.2 N.m.

2.7 Connect the Modem to External Device

Connect a serial cable to the DB9 female connector at the bottom of the M1000 MP Modem, and connect the other

end of the cable to an external controller or computer. Here takes RS-232 port as an example.

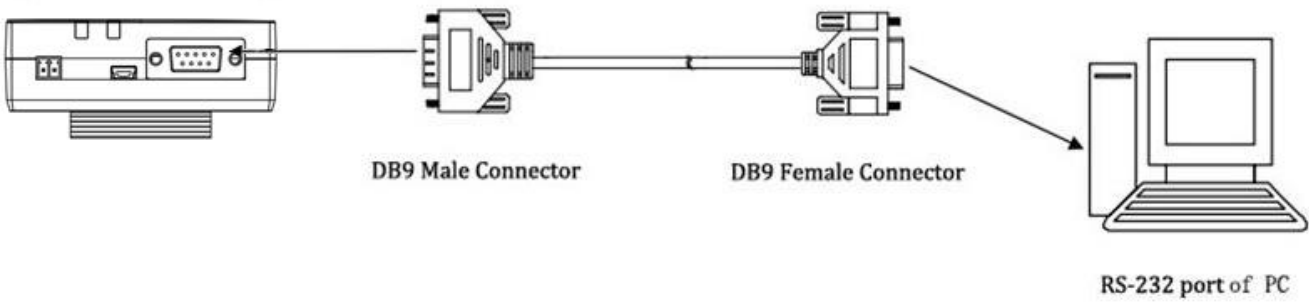

Connect an USB cable to the mini USB connector at the bottom of the M1000 MP Modem, and connect the other end of the cable to an external controller or computer.

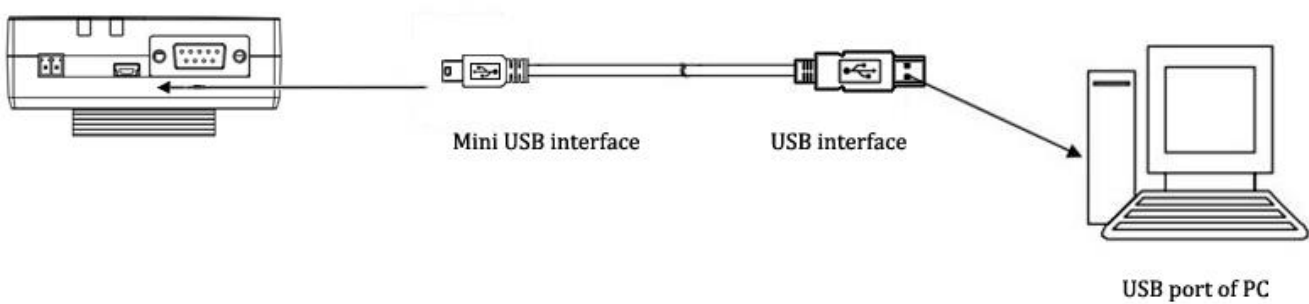

2.8 Power Supply

CONNECTING THE POWER CABLE

COLOR	POLARITY
RED	+
YELLOW	-

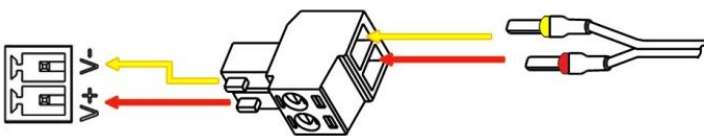

M1000 MP supports reverse polarity protection, but always refers to the figure above to connect the power adapter correctly. There are two cables associated with the power adapter. Following to the color of the head, connect the cable marked red to the positive pole through a terminal block, and connect the yellow one to the negative in the same way. The last step is to plug the power adapter into your socket.

Note: The range of power voltage is 6 to 36V DC.

Chapter 2 Modem Operation

You can use AT commands to operate and configure the M1000 MP Modem through the mini USB port or serial port. This chapter will mainly introduce AT commands examples about how to configure the M1000 MP Modem.

3.1 AT Command Set

M1000 MP supports the guidelines known as “AT Command Set”. AT Command Set is an industry standard line-oriented command language used to communicate with the modem. You can enter AT commands to configure the M1000 MP Modem by serial software, such as SecureCRT.

3.1.1 Start SecureCRT

1. Double-click “SecureCRT Potable.exe” to open the software.



2. Click **File > Connect**, and create a new session.

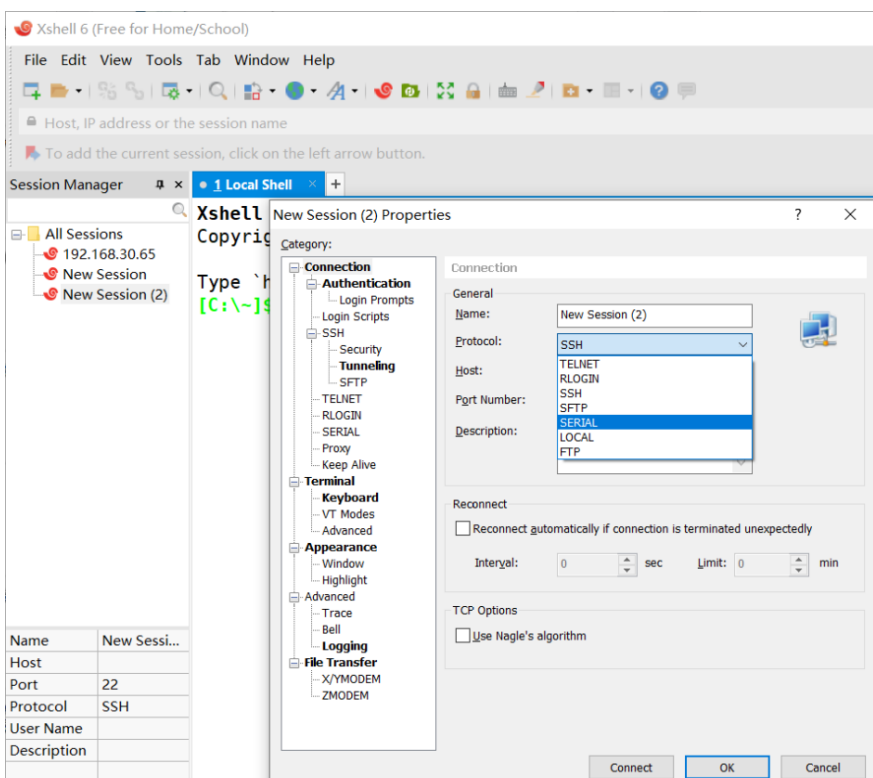

3. Choose "Serial" as the protocol.

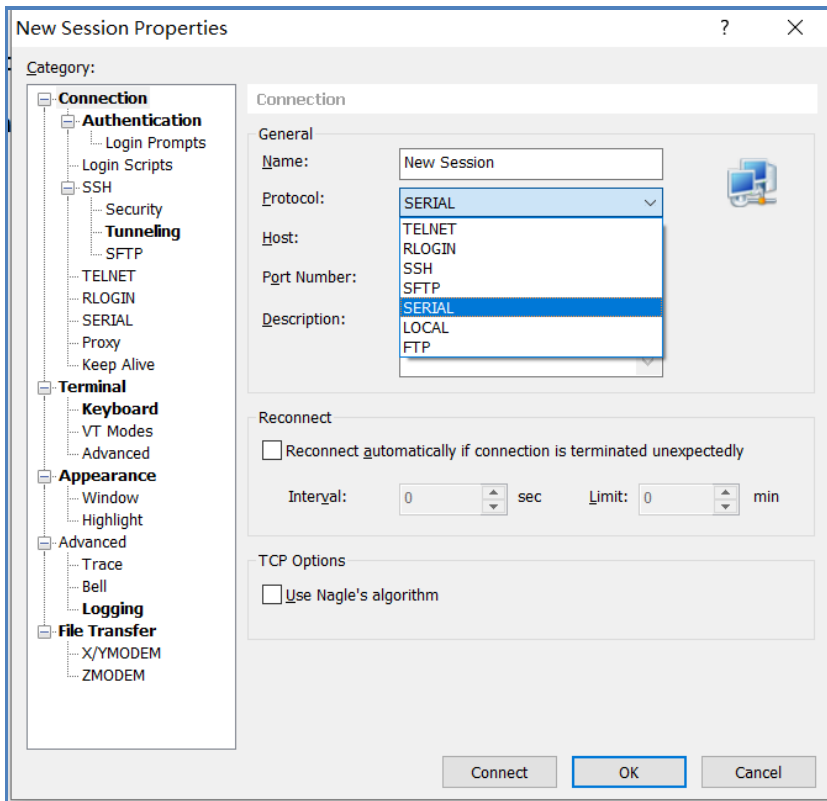

4. Choose the relevant COM port and match the parameters as below, then click "Next".

Note: Please be sure to configure the parameters as following: 115200, 8, n, 1, and disable "RTS/CTS".

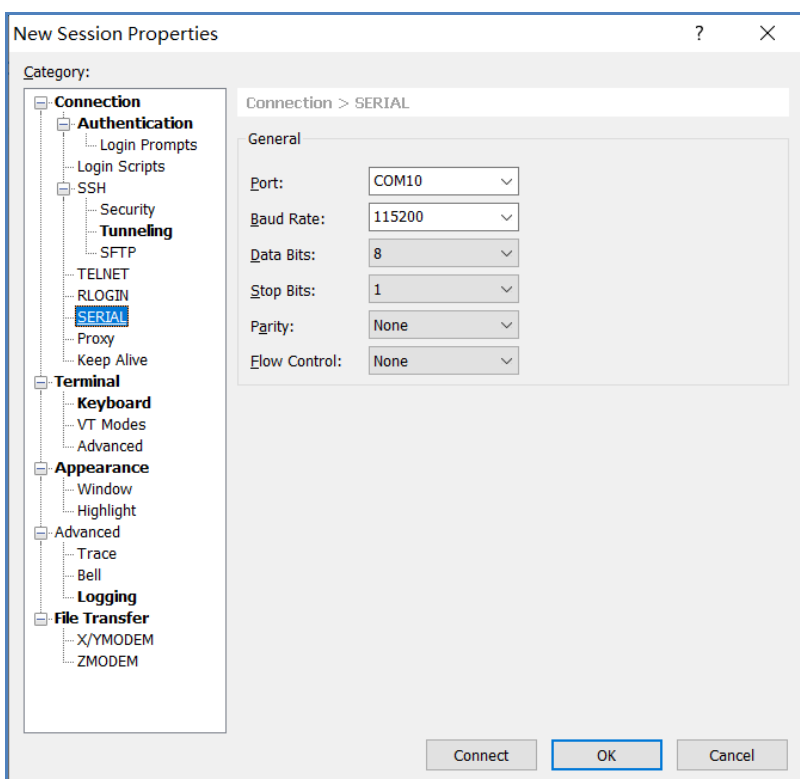

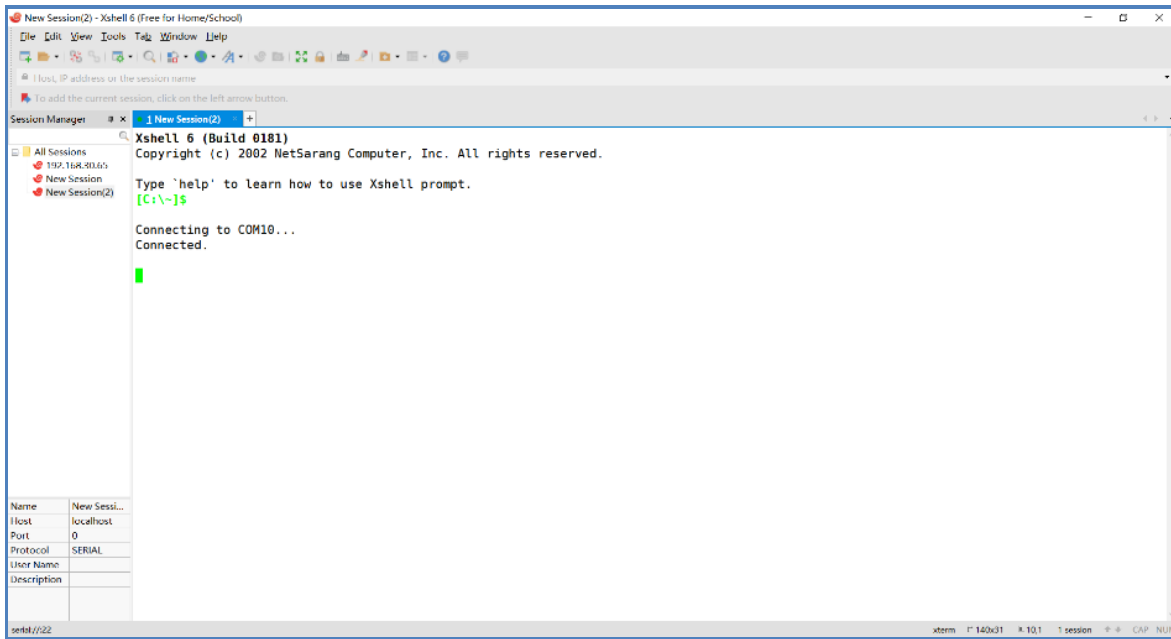

3.1.2 AT Command Examples

Following are some examples of the AT commands. For more detailed description, please refer to the AT command guide for the module.

Description	AT Commands	Modem Response	Comments
Modem confirm	AT	OK	Responding OK indicates that the modem is ready.
Receiving signal strength	AT+CSQ	+CSQ: 19,99	The first parameter is at least greater than or equal to 15 to ensure normal communication.
Query current PIN status	AT+CPIN?	+CPIN: READY	The SIM card is correctly inserted and the modem needs no password.
		+CPIN: SIM PIN	PIN is required.
		+CPIN: SIM PUK	PUK is required.
Save parameters to non-volatile memory	AT&W	OK	The configuring and modifying are saved.

3.2 Using Short Message Service

Cellular technology offers the benefit of using SMS (short message service) as an easy way to communicate over the mobile network. The following topics are covered in this chapter:

1. Sending a Short Message
2. Reading a Short Message
3. Deleting a Short Message

3.2.1 Sending a Short Message

1. Type **AT+CMGF=1** and press **Enter**.
2. Type **AT+CMGS=<phone number>** and press **Enter**. The terminal will automatically move to the next line, which starts with a **>**. Type your message on the right of the **>**.
3. Enter **Ctrl + Z** to deliver the message.

```
at
OK
at+cmgf=1
OK
at+cmgs="123456"
> SMS Test #1
OK
+CMGS: 250
```

Note: **AT+CMGF=1** is used to set the SMS as Text mode.

3.2.2 Reading a Short Message

1. Type **AT+CMGF=1** and press **Enter**.
2. Type **AT+CNMI=2,1** and press **Enter**.
3. When a short message is received, the window will show **+CMIT: "SM", x**, in which the **x** is the index number for SMS save position.
4. Type **AT+CMGR=x** to read the message, in which the **x** is the index number for SMS save position.
5. The **x=5** means that the message is stored in the 5th storage location, as shown below.

```
at
OK
+CMIT: "SM",5
at+cmgr=5
+CMGR: "REC UNREAD","+886972613404",,"07/03/19,00:36:24+32"
SMS Test #1
OK
```

3.2.3 Deleting a Short Message

Type **AT+CMGD=*x*,*n*** and press **Enter**.

Here the *x* represents one of the following options:

- “**REC UNREAD**” showing the unread messages
- “**REC READ**” showing the read messages
- “**STO UNSENT**” showing the unsent and saved messages
- “**STO SENT**” showing the sent messages
- “**ALL**” showing all the messages

Here the *n* represents one of the following options:

- 0** Delete the message in the save position, including the index number
- 1** Delete all read messages
- 2** Delete all read and sent messages
- 3** Delete all read, send, and unsent messages
- 4** Delete all messages

Note: The SMS sending command may a little different vary from module to module. For the specific command of different module, the corresponding AT document shall prevail, or contact our Technical Support.

3.3 GPRS Connection

3.3.1 Overview

GPRS is a packet-switched technology, enabling multiple users to share the same transmission channel. In addition, GPRS will transmit when there is outgoing data. This means that the available bandwidth can be dedicated solely to data communication when needed. In general, a GPRS network can be seen as a special IP network offering IP connectivity to IP terminals. Devices such as PCs, embedded computers, and PLCs that are PPP-enabled can be easily connected to the IP network and the Internet.

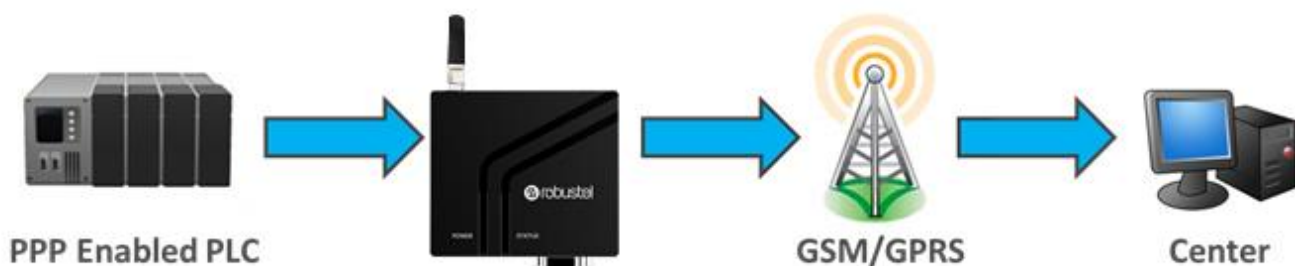

3.3.2 Windows GPRS Access

The modem can use Windows DUN (Dial-up Networking) to provide the Internet access through the GPRS mobile network. The following are the steps about how to dial via Windows.

Note: The following steps are based on Windows 7, so the specific steps may vary depending on your version of Windows and your Windows settings.

- **Changing the baud rate of the modem**

1. Configure the modem's baud rate as 115200.

```
at
OK
at+ipr=115200
OK
```

- **Installing the modem driver**

1. In the Control Panel, open “**Phone and Modem**”, click the “Modem” tab, then click **Add** to add a new modem.

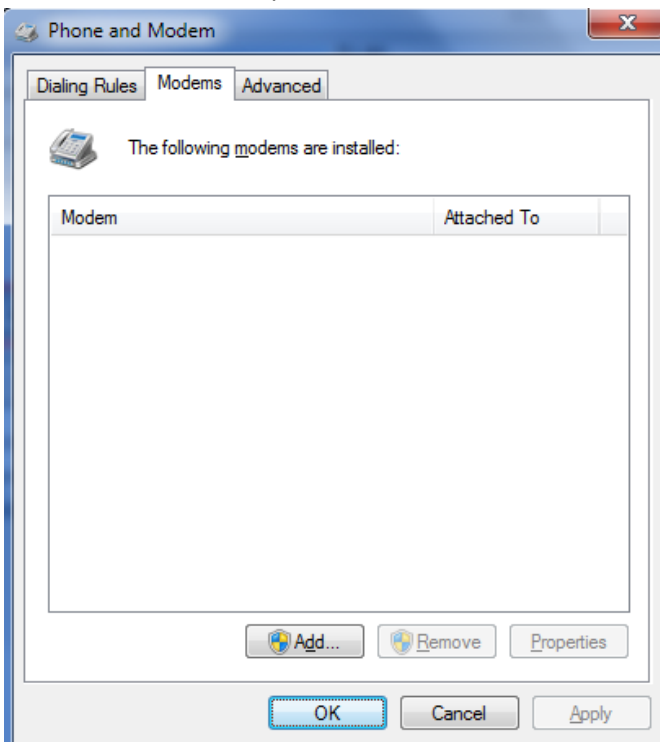

Note: If you access the “Phone and Modem” tool for the first time, The Windows will ask you to input your area code before you can proceed.

- When the “Add Hardware Wizard” window pops out, select “**Don’t detect my modem, I will select it from a list**” and click **Next**.

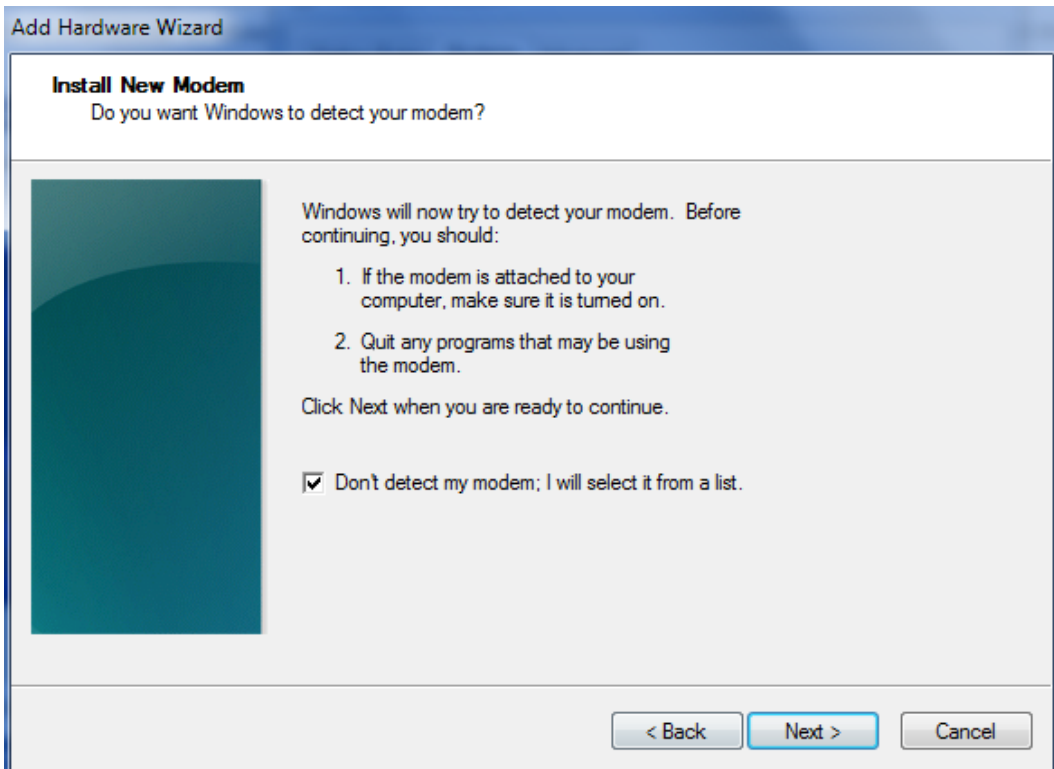

- Choose **Standard 33600 bps Modem** and click **Next**.

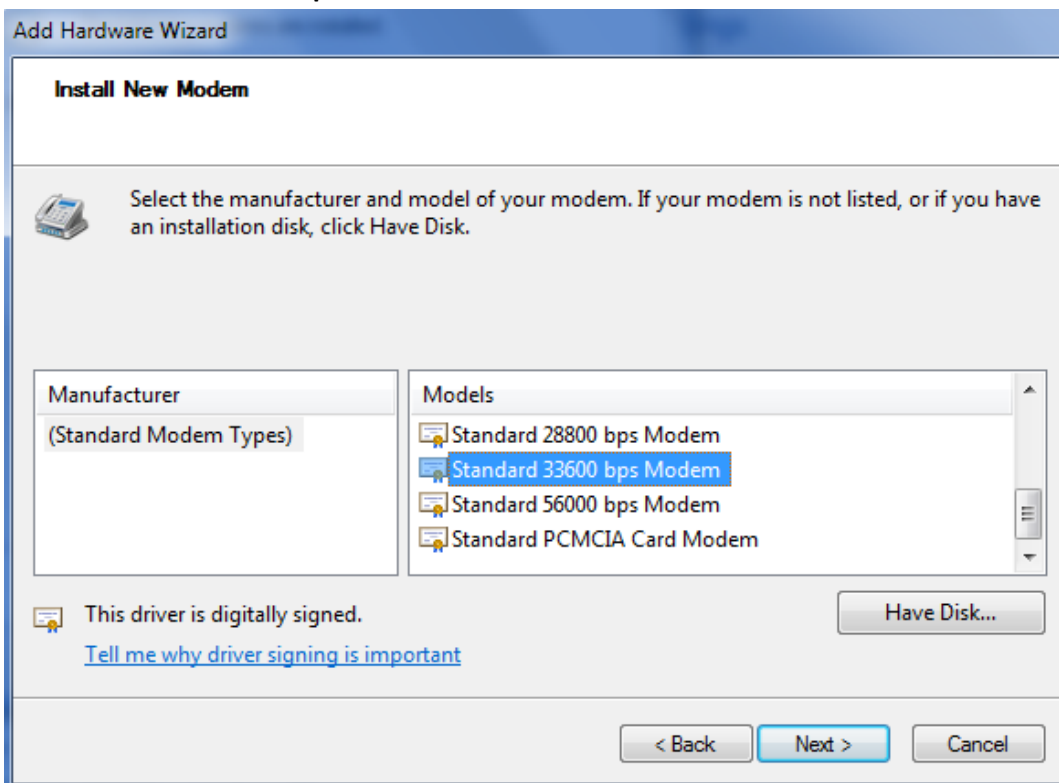

- Choose the selected port that the modem wants to connect to the computer and click **Next**.

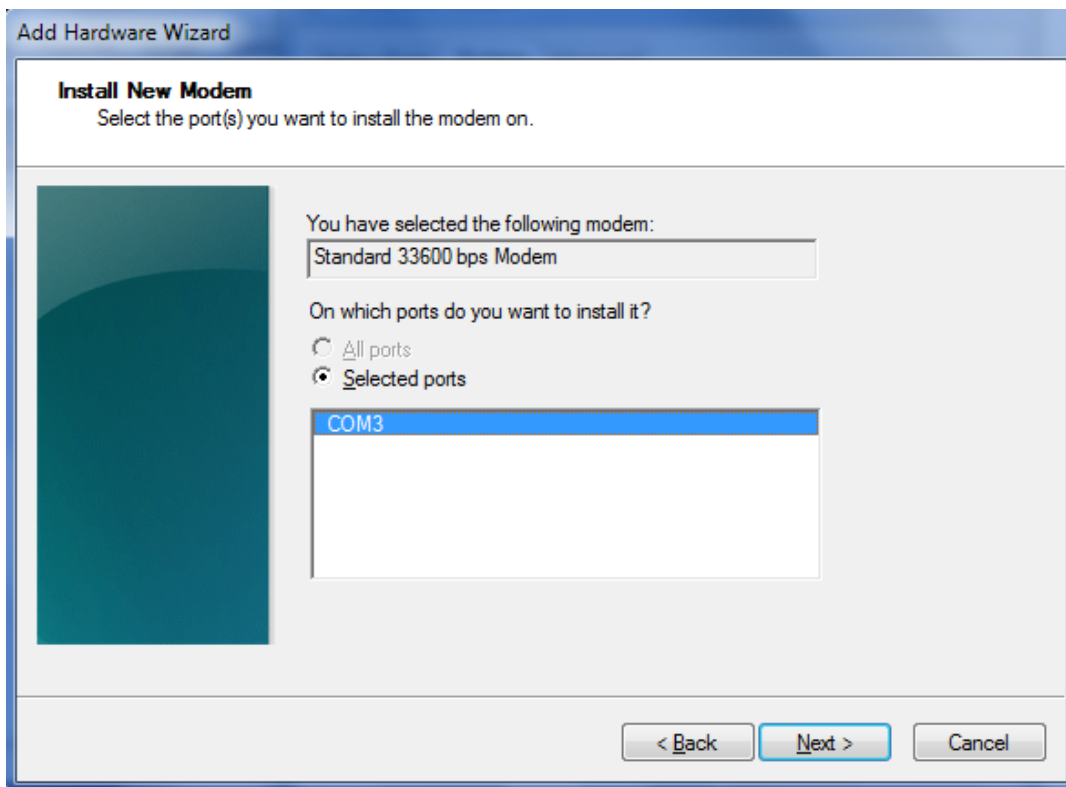

5. Click **Finish** to finish the modem installation.

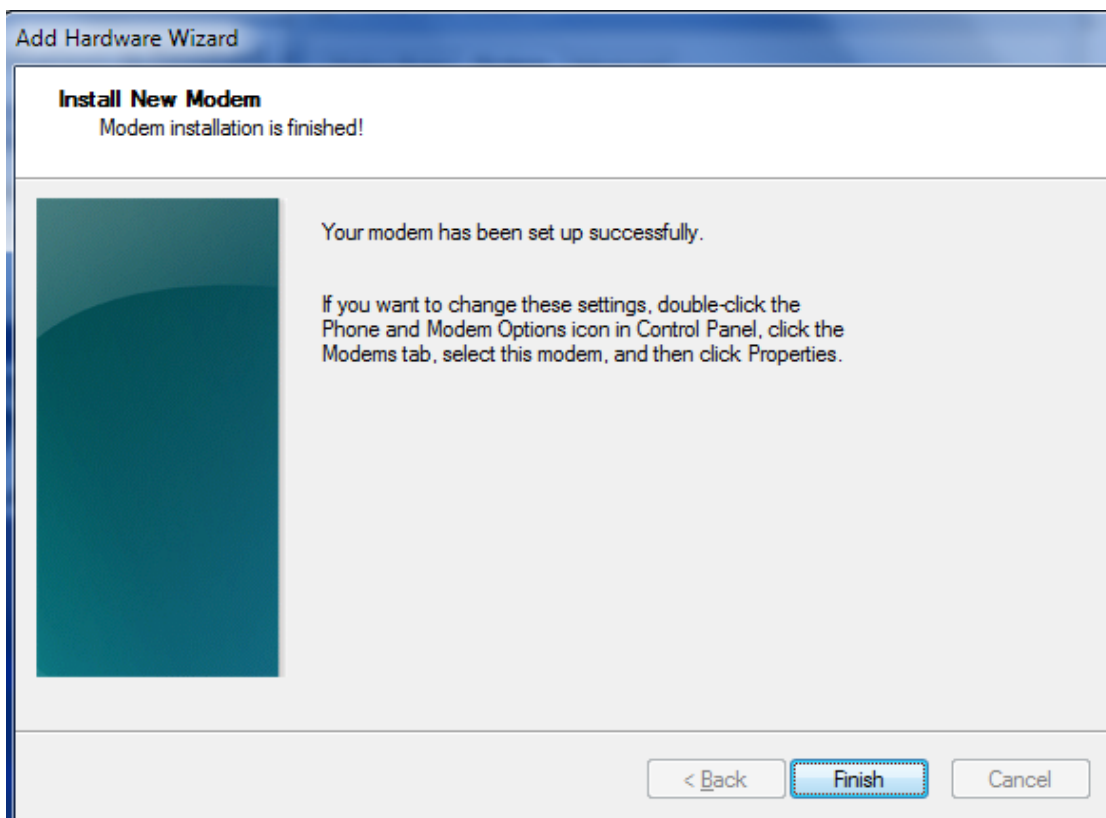

6. The new modem will be listed on the **Modems** tab.

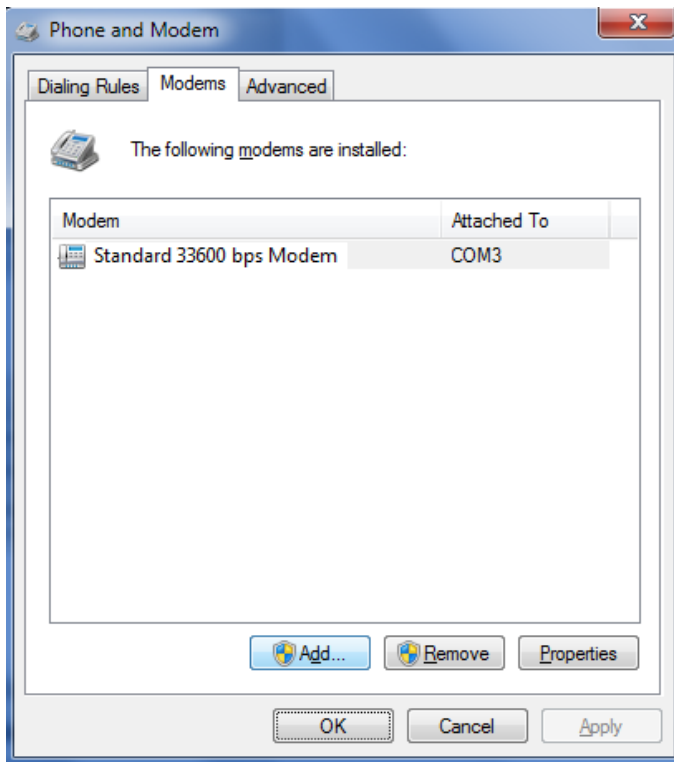

- **Set Maximum Port Speed**

1. Double-click "Standard 33600 bps Modem" and click **Properties**.

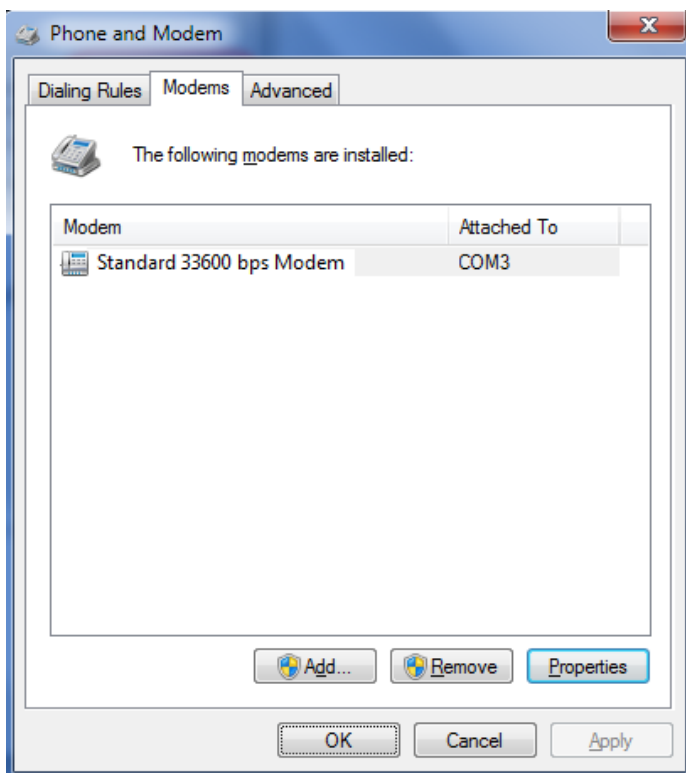

2. Next, click the **Modem** tab, select "115200" as the **Maximum Port Speed** and click **OK**.

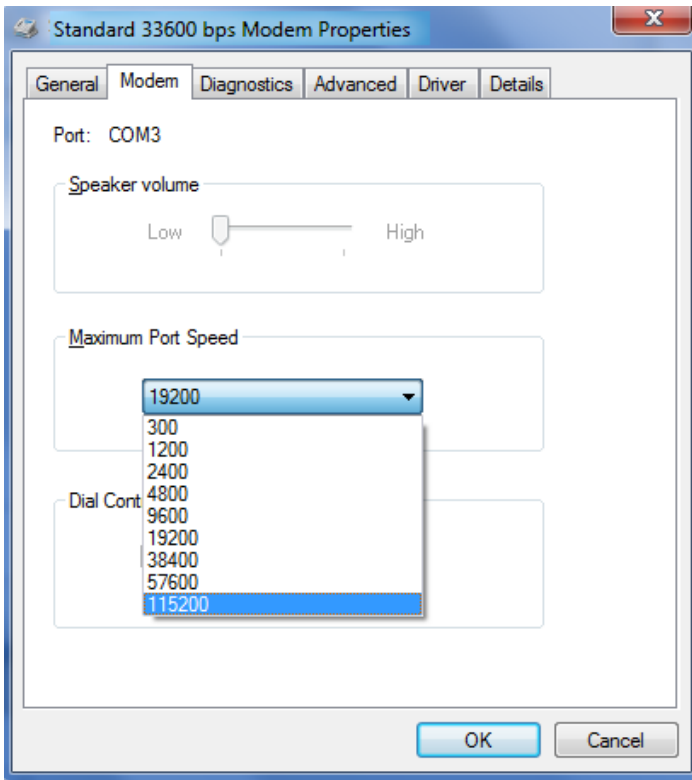

- **Modem Diagnostics**

Follow these steps to verify that the modem is installed properly and has been activated.

1. Click the **Diagnostics** tab and click **Query Modem**. It will pop up a **“Please Wait”** window in about 2 seconds.

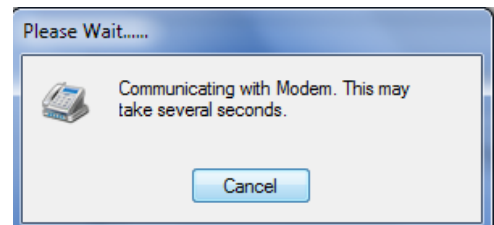
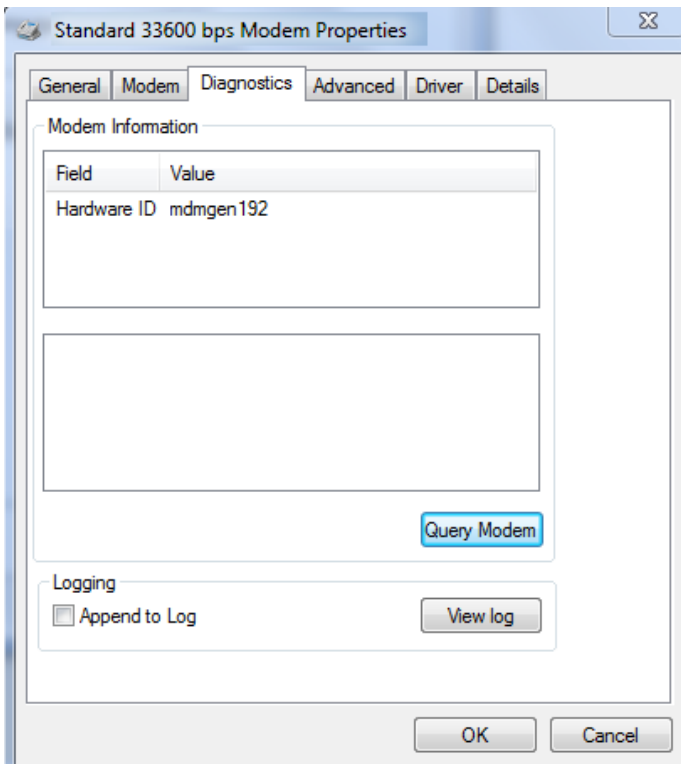

2. If the query is successful, both commands sent to the modem and responses from the modem will be displayed.

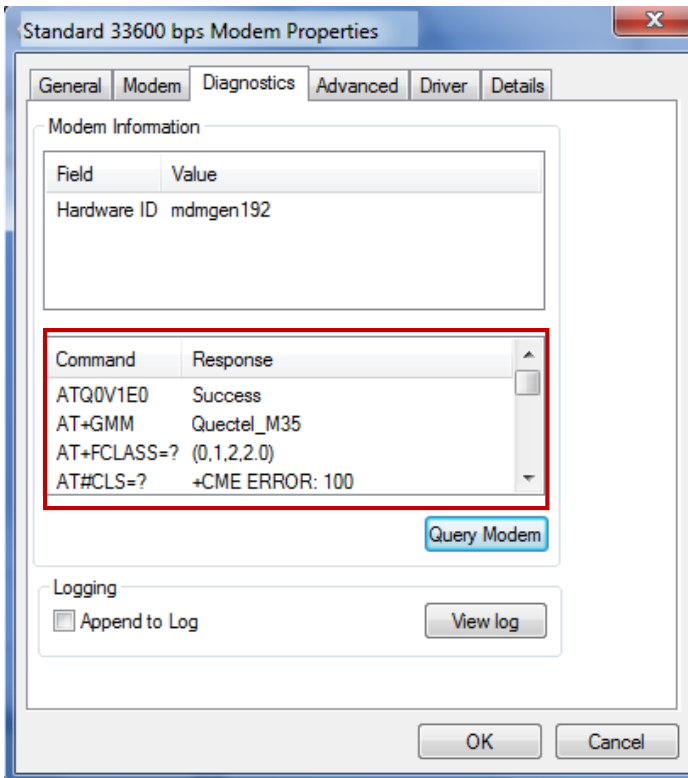

- **Setting up the APN**

The APN (Access Point Name) must be added to the modem as a modem initialization command before the Windows dial-up. The following are the steps about how to add the APN command.

1. Click the **Advanced** tab.
2. Enter the following commands in the field of **Extra initialization commands**:

AT+CGDCONT=1,"IP", "<APN>"

Replace <APN> with the correct service for your account, for example:

AT+CGDCONT=1,"IP", "3gnet"

Dial via USB port:

ATZ+CGDCONT=1,"IP", "3gnet";

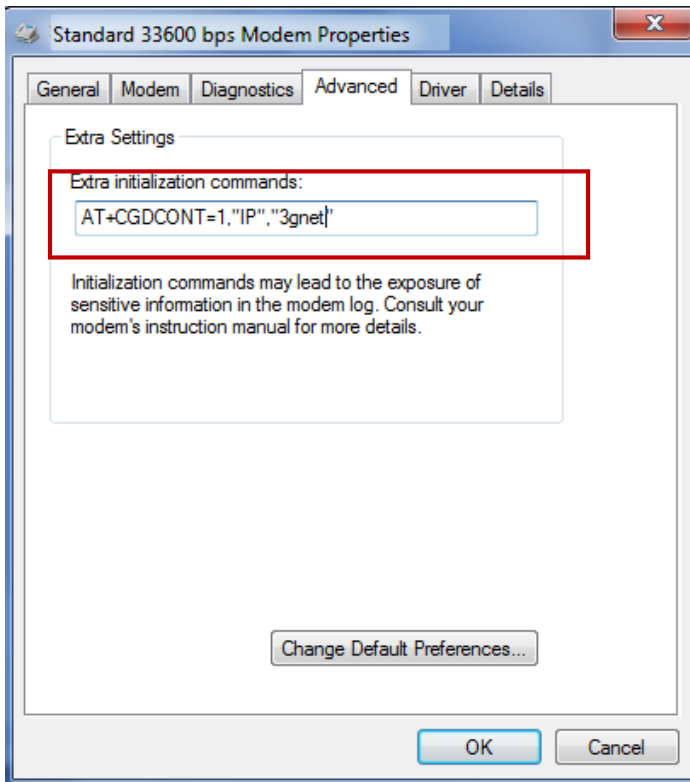

3. Click **Change Default Preferences**.

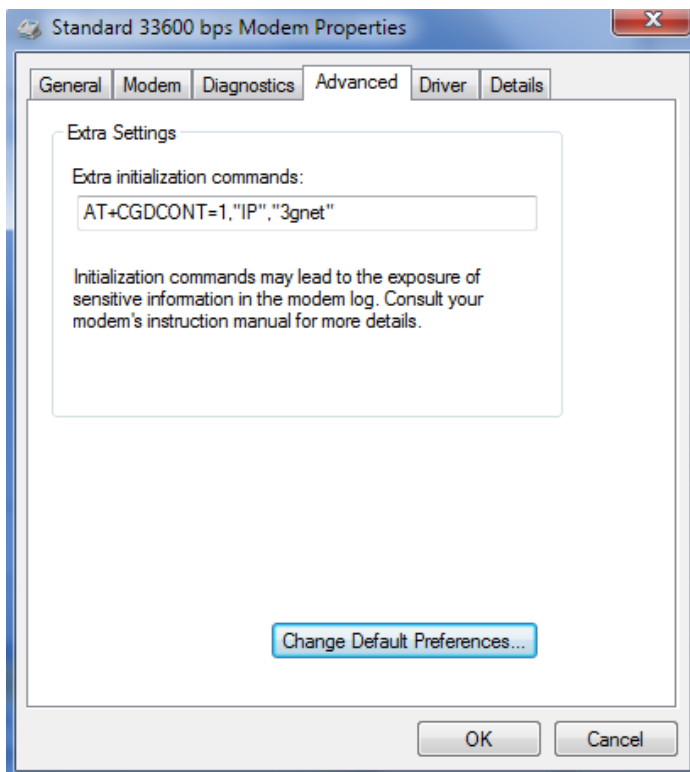

- Choose "115200" as the port speed and "None" as the flow control, and then click **OK**.

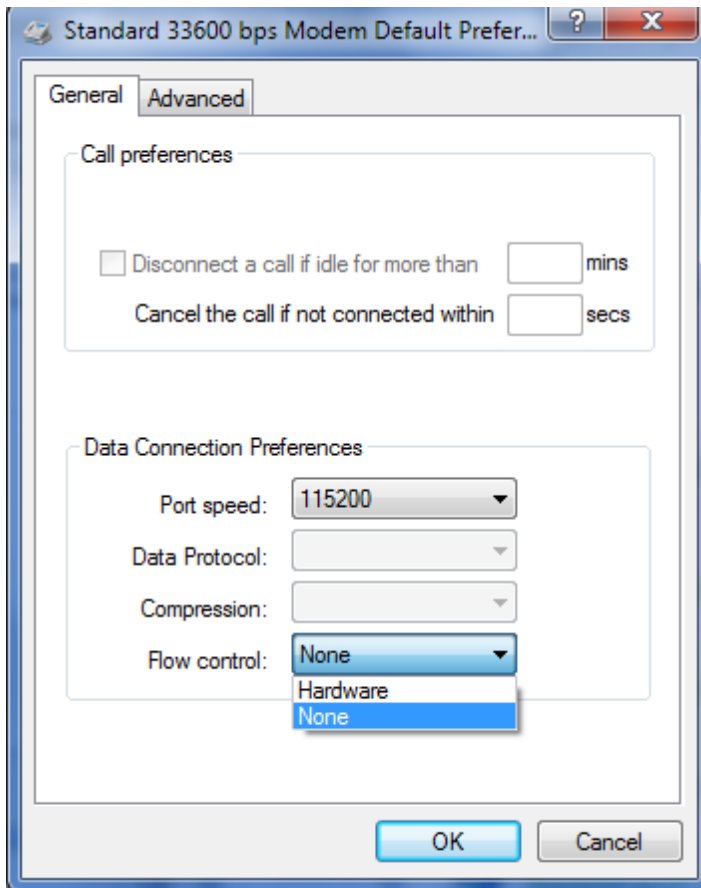

- Click **OK** to close the **Properties** window.
- Click **OK** to close the **Modems** window.

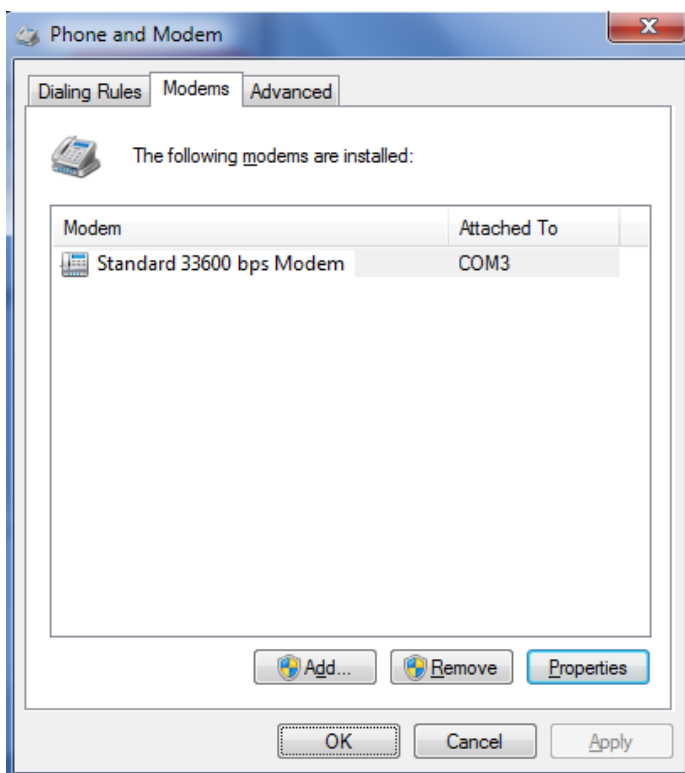

- **Adding Windows DUN**

The following are the steps about how to add the Windows Dial-up Networking.

1. In the Control Panel, open **Network and Sharing Center** and click **Set up a new connection or network**.
2. In the **Set Up a Connection or Network** window, select **Connect to the Internet** and click **Next**.

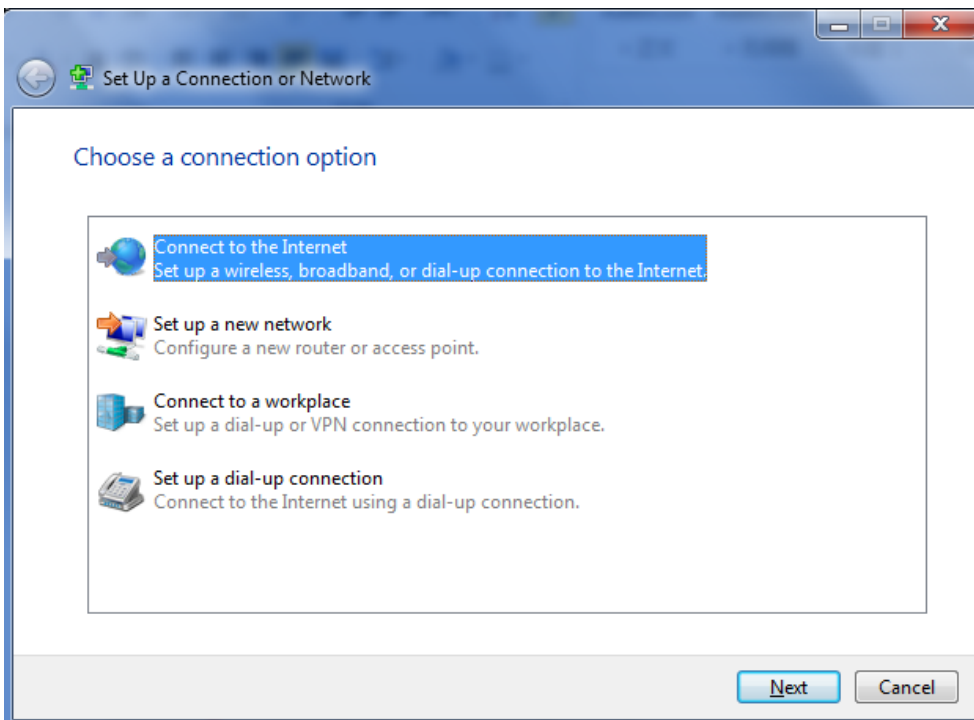

3. Choose **No, create a new connection** and click **Next**.

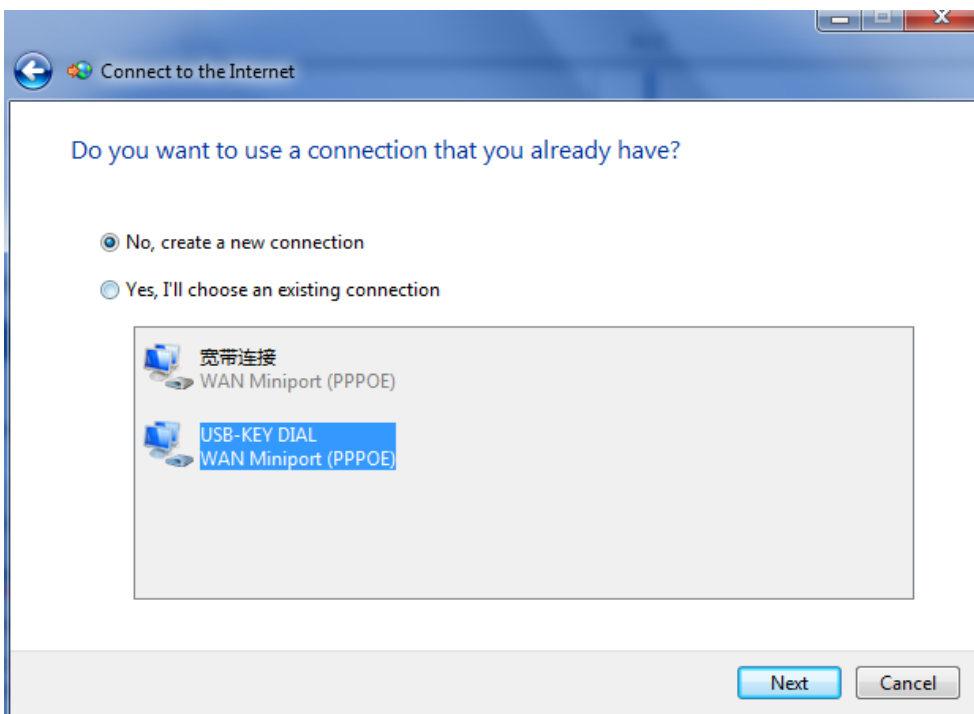

4. Choose the **Dial up** option.

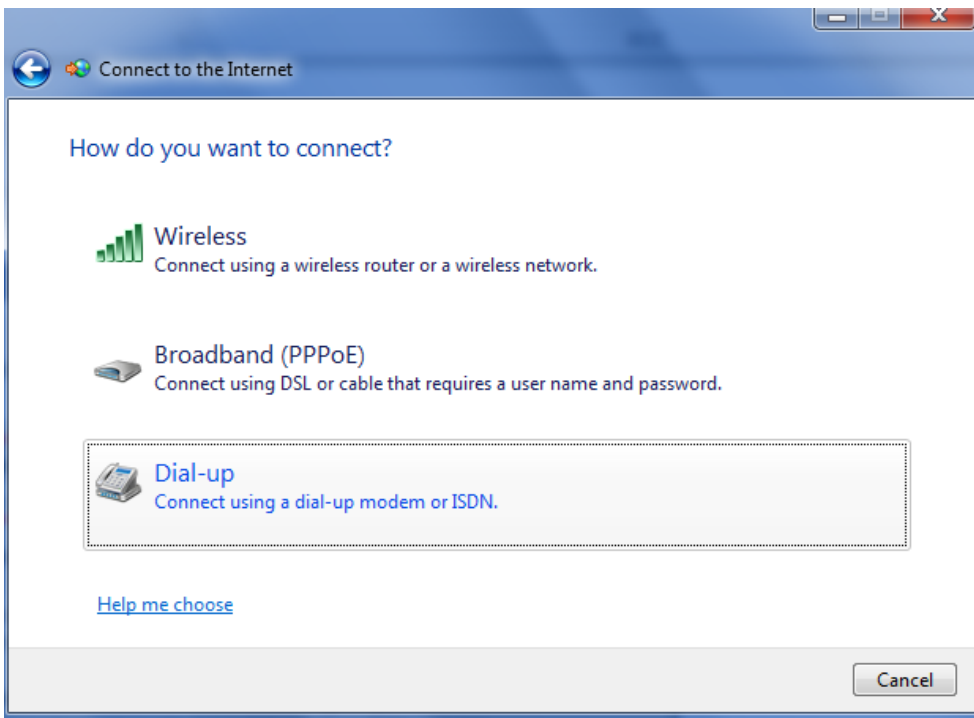

5. Type ***99***1#** in the Dial-up phone number box, type the **User name** and **Password** in the corresponding boxes, and click **Connect**.

Note: **User Name** and **Password** are used for cellular dial-up connection. Please check with your local ISP to see whether you should type.

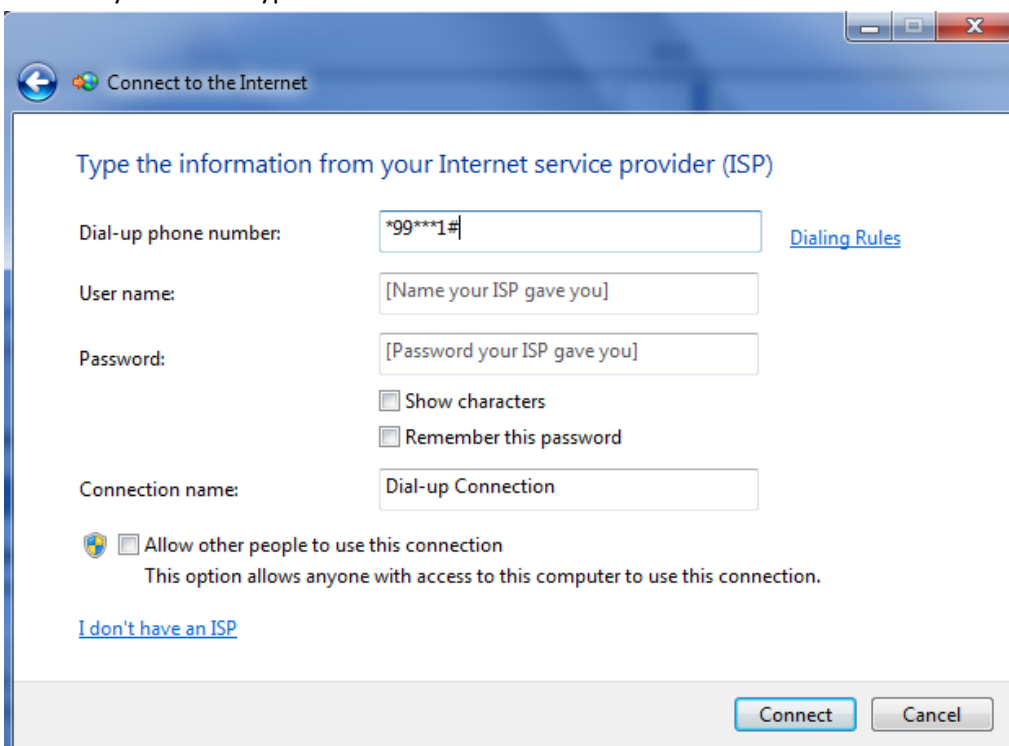

6. After the dialing up is completed, the window is shown below.



7. Ping www.google.com to check whether GPRS connection has been established.

```
Administrator: C:\Windows\system32\cmd.exe
Microsoft Windows [Version 6.1.7601]
Copyright (c) 2009 Microsoft Corporation. All rights reserved.

C:\Users\Administrator>ping www.google.com

Pinging www.google.com [173.194.127.49] with 32 bytes of data:
Reply from 173.194.127.49: bytes=32 time=1837ms TTL=50
Reply from 173.194.127.49: bytes=32 time=359ms TTL=50
Request timed out.
Reply from 173.194.127.49: bytes=32 time=214ms TTL=50

Ping statistics for 173.194.127.49:
    Packets: Sent = 4, Received = 3, Lost = 1 (25% loss),
    Approximate round trip times in milli-seconds:
        Minimum = 214ms, Maximum = 1837ms, Average = 803ms

C:\Users\Administrator>
```

Chapter 3 Appendix

4.1 GSM Alphabet

A standard SMS consists of 160 characters, and which must be 7-bit default alphabet specified by GSM 3.38 character set. The following character table contains all ASCII characters and other accented characters. For example, u umlaut (ü) and e with grave (è), are in this set. Please see the table below for more information. If the character you would like to find is not in the following list, please use the Unicode to make your SMS. The permissible character length of the SMS is 70 characters.

Note: A few characters actually count as two characters, e.g. {}[]~|\ and the Euro symbol: €

Hex	Dec	Character Representation	Character	ISO-8859-1 DEC
0x00	0	COMMERCIAL AT	@	64
0x01	1	POUND SIGN	£	163
0x02	2	DOLLAR SIGN	\$	36
0x03	3	YEN SIGN	¥	165
0x04	4	LATIN SMALL LETTER E WITH GRAVE	è	232
0x05	5	LATIN SMALL LETTER E WITH ACUTE	é	233
0x06	6	LATIN SMALL LETTER U WITH GRAVE	ù	249
0x07	7	LATIN SMALL LETTER I WITH GRAVE	ì	236
0x08	8	LATIN SMALL LETTER O WITH GRAVE	ò	242
0x09	9	LATIN CAPITAL LETTER C WITH CEDILLA	Ç	199
0x0A	10	LINE FEED		10
0x0B	11	LATIN CAPITAL LETTER O WITH STROKE	Ø	216
0x0C	12	LATIN SMALL LETTER O WITH STROKE	ø	248
0x0D	13	CARRIAGE RETURN		13
0x0E	14	LATIN CAPITAL LETTER A WITH RING ABOVE	Å	197
0x0F	15	LATIN SMALL LETTER A WITH RING ABOVE	å	229
0x10	16	GREEK CAPITAL LETTER DELTA	Δ	
0x11	17	LOW LINE	_	95
0x12	18	GREEK CAPITAL LETTER PHI	Φ	
0x13	19	GREEK CAPITAL LETTER GAMMA	Γ	
0x14	20	GREEK CAPITAL LETTER LAMBDA	Λ	
0x15	21	GREEK CAPITAL LETTER OMEGA	Ω	
0x16	22	GREEK CAPITAL LETTER PI	Π	
0x17	23	GREEK CAPITAL LETTER PSI	Ψ	
0x18	24	GREEK CAPITAL LETTER SIGMA	Σ	
0x19	25	GREEK CAPITAL LETTER THETA	Θ	
0x1A	26	GREEK CAPITAL LETTER XI	Ξ	
0x1B	27	ESCAPE TO EXTENSION TABLE		
0x1B0A	27 10	FORM FEED		12
0x1B14	27 20	CIRCUMFLEX ACCENT	^	94

0x1B28	27 40	LEFT CURLY BRACKET	{	123
0x1B29	27 41	RIGHT CURLY BRACKET	}	125
0x1B2F	27 47	REVERSE SOLIDUS (BACKSLASH)	\	92
0x1B3C	27 60	LEFT SQUARE BRACKET	[91
0x1B3D	27 61	TILDE	~	126
0x1B3E	27 62	RIGHT SQUARE BRACKET]	93
0x1B40	27 64	VERTICAL BAR		124
0x1B65	27 101	EURO SIGN	€	164 (ISO-8859-15)
0x1C	28	LATIN CAPITAL LETTER AE	Æ	198
0x1D	29	LATIN SMALL LETTER AE	æ	230
0x1E	30	LATIN SMALL LETTER SHARP S (German)	ß	223
0x1F	31	LATIN CAPITAL LETTER E WITH ACUTE	É	201
0x20	32	SPACE		32
0x21	33	EXCLAMATION MARK	!	33
0x22	34	QUOTATION MARK	“	34
0x23	35	NUMBER SIGN	#	35
0x24	36	CURRENCY SIGN	¤	164 (ISO-8859-1)
0x25	37	PERCENT SIGN	%	37
0x26	38	AMPERSAND	&	38
0x27	39	APOSTROPHE	'	39
0x28	40	LEFT PARENTHESIS	(40
0x29	41	RIGHT PARENTHESIS)	41
0x2A	42	ASTERISK	*	42
0x2B	43	PLUS SIGN	+	43
0x2C	44	COMMA	,	44
0x2D	45	HYPHEN-MINUS	-	45
0x2E	46	FULL STOP	.	46
0x2F	47	SOLIDUS (SLASH)	/	47
0x30	48	DIGIT ZERO	0	48
0x31	49	DIGIT ONE	1	49
0x32	50	DIGIT TWO	2	50
0x33	51	DIGIT THREE	3	51
0x34	52	DIGIT FOUR	4	52
0x35	53	DIGIT FIVE	5	53
0x36	54	DIGIT SIX	6	54
0x37	55	DIGIT SEVEN	7	55
0x38	56	DIGIT EIGHT	8	56
0x39	57	DIGIT NINE	9	57
0x3A	58	COLON	:	58
0x3B	59	SEMICOLON	;	59
0x3C	60	LESS-THAN SIGN	<	60
0x3D	61	EQUALS SIGN	=	61
0x3E	62	GREATER-THAN SIGN	>	62
0x3F	63	QUESTION MARK	?	63

0x40	64	INVERTED EXCLAMATION MARK	¡	161
0x41	65	LATIN CAPITAL LETTER A	A	65
0x42	66	LATIN CAPITAL LETTER B	B	66
0x43	67	LATIN CAPITAL LETTER C	C	67
0x44	68	LATIN CAPITAL LETTER D	D	68
0x45	69	LATIN CAPITAL LETTER E	E	69
0x46	70	LATIN CAPITAL LETTER F	F	70
0x47	71	LATIN CAPITAL LETTER G	G	71
0x48	72	LATIN CAPITAL LETTER H	H	72
0x49	73	LATIN CAPITAL LETTER I	I	73
0x4A	74	LATIN CAPITAL LETTER J	J	74
0x4B	75	LATIN CAPITAL LETTER K	K	75
0x4C	76	LATIN CAPITAL LETTER L	L	76
0x4D	77	LATIN CAPITAL LETTER M	M	77
0x4E	78	LATIN CAPITAL LETTER N	N	78
0x4F	79	LATIN CAPITAL LETTER O	O	79
0x50	80	LATIN CAPITAL LETTER P	P	80
0x51	81	LATIN CAPITAL LETTER Q	Q	81
0x52	82	LATIN CAPITAL LETTER R	R	82
0x53	83	LATIN CAPITAL LETTER S	S	83
0x54	84	LATIN CAPITAL LETTER T	T	84
0x55	85	LATIN CAPITAL LETTER U	U	85
0x56	86	LATIN CAPITAL LETTER V	V	86
0x57	87	LATIN CAPITAL LETTER W	W	87
0x58	88	LATIN CAPITAL LETTER X	X	88
0x59	89	LATIN CAPITAL LETTER Y	Y	89
0x5A	90	LATIN CAPITAL LETTER Z	Z	90
0x5B	91	LATIN CAPITAL LETTER A WITH DIAERESIS	Ä	196
0x5C	92	LATIN CAPITAL LETTER O WITH DIAERESIS	Ö	214
0x5D	93	LATIN CAPITAL LETTER N WITH TILDE	Ñ	209
0x5E	94	LATIN CAPITAL LETTER U WITH DIAERESIS	Ü	220
0x5F	95	SECTION SIGN	§	167
0x60	96	INVERTED QUESTION MARK	¿	191
0x61	97	LATIN SMALL LETTER A	a	97
0x62	98	LATIN SMALL LETTER B	b	98
0x63	99	LATIN SMALL LETTER C	c	99
0x64	100	LATIN SMALL LETTER D	d	100
0x65	101	LATIN SMALL LETTER E	e	101
0x66	102	LATIN SMALL LETTER F	f	102
0x67	103	LATIN SMALL LETTER G	g	103
0x68	104	LATIN SMALL LETTER H	h	104
0x69	105	LATIN SMALL LETTER I	i	105
0x6A	106	LATIN SMALL LETTER J	j	106
0x6B	107	LATIN SMALL LETTER K	k	107

0x6C	108	LATIN SMALL LETTER L	l	108
0x6D	109	LATIN SMALL LETTER M	m	109
0x6E	110	LATIN SMALL LETTER N	n	110
0x6F	111	LATIN SMALL LETTER O	o	111
0x70	112	LATIN SMALL LETTER P	p	112
0x71	113	LATIN SMALL LETTER Q	q	113
0x72	114	LATIN SMALL LETTER R	r	114
0x73	115	LATIN SMALL LETTER S	s	115
0x74	116	LATIN SMALL LETTER T	t	116
0x75	117	LATIN SMALL LETTER U	u	117
0x76	118	LATIN SMALL LETTER V	v	118
0x77	119	LATIN SMALL LETTER W	w	119
0x78	120	LATIN SMALL LETTER X	x	120
0x79	121	LATIN SMALL LETTER Y	y	121
0x7A	122	LATIN SMALL LETTER Z	z	122
0x7B	123	LATIN SMALL LETTER A WITH DIAERESIS	ä	228
0x7C	124	LATIN SMALL LETTER O WITH DIAERESIS	ö	246
0x7D	125	LATIN SMALL LETTER N WITH TILDE	ñ	241
0x7E	126	LATIN SMALL LETTER U WITH DIAERESIS	ü	252
0x7F	127	LATIN SMALL LETTER A WITH GRAVE	à	224

4.2 Troubleshooting

This section introduces frequently asked questions and corresponding solutions in use.

4.2.1 What should I do if the LED indicator doesn't work?

- Check if the power adapter is matched
- Check if the power adapter has been properly plugged

4.2.2 What should I do if the modem always keeps restarting?

- Check if the SIM card has been properly inserted

4.2.3 What should I do if the serial port connection fails?

- Check if the serial cable has been connected
- Check if the pin assignment of the serial cable has been properly connected

- Check if the serial parameters have been correctly configured, and the factory settings of the serial port are 115200, 8, n, 1
- Check if there is another program interfering with the communication program, such as a port conflict

4.2.4 What should I do if the modem receives the “No Carrier” message?

If the modem returns a “No Carrier” message upon an attempted call (voice or data), then refer to the table below for possible causes and solutions.

If the modem returns...	Then ask...	Action...
“No Carrier”	Is the received signal strong enough?	Use “AT+CSQ” to check RSSI, and see the Signal Strength Indication table below for more information.
	Is the antenna properly connected?	Refer to Chapter 2.5.
“No Carrier” (when trying to issue a voice communication)	Is the semicolon (;) entered immediately after the phone number in the AT command?	Ensure that the semicolon (;) is entered immediately after the phone number in the AT command, e.g. ATD123456;
“No Carrier” (when trying to issue a data communication)	Is the SIM card configured as data/fax calls?	Configure the SIM card as data/fax calls (ask your network provider if necessary).
	Is the selected bearer type supported by the called party?	Ensure that the selected bearer type is supported by the called party.
	Is the selected bearer type supported by the network?	Ensure that the selected bearer type is supported by the network. If no success, try bearer select type by AT command: AT+CBST=0,0,3

Signal Strength Indication

Received Signal Strength Indication (RSSI)	Description
0 to 12	Low signal strength
13 to 19	Medium signal strength
20 to 31	High signal strength
99	No signal

4.3 Glossary

Abbreviations	Description
AC	Alternating Current
APN	Access Point Name of GPRS Service Provider Network
CE	Conformité Européene (European Conformity)
CHAP	Challenge Handshake Authentication Protocol
CTS	Clear to Send
dB	Decibel
dBi	Decibel Relative to an Isotropic radiator
DC	Direct Current
DCD	Data Carrier Detect
DCE	Data Communication Equipment (typically modems)
DCS 1800	Digital Cellular System, also referred to as PCN
DI	Digital Input
DO	Digital Output
DSR	Data Set Ready
DTE	Data Terminal Equipment
DTMF	Dual Tone Multi-frequency
DTR	Data Terminal Ready
EMC	Electromagnetic Compatibility
EMI	Electromagnetic Interference
ETSI	European Telecommunications Standards Institute
GND	Ground
GPRS	General Package Radio Service
GSM	Global Standard for Mobile Communications
IMEI	International Mobile Equipment Identification
kbps	kbits per second
LED	Light Emitting Diode
MAX	Maximum
Min	Minimum
MO	Mobile Originated
MS	Mobile Station
MT	Mobile Terminated
PAP	Password Authentication Protocol
PC	Personal Computer
PCN	Personal Communications Network, also referred to as DCS 1800
PCS	Personal Communication System, also referred to as GSM 1900
PDU	Protocol Data Unit
PPP	Point-to-point Protocol
PIN	Personal Identity Number
PSU	Power Supply Unit

PUK	Personal Unblocking Key
R&TTE	Radio and Telecommunication Terminal Equipment
RF	Radio Frequency
RTS	Request to Send
Rx	Receive Direction
SIM	Subscriber Identification Module
SMA	Subminiature Version A RF Connector
SMS	Short Message Service
TCP/IP	Transmission Control Protocol / Internet Protocol
TE	Terminal Equipment, also referred to as DTE
Tx	Transmit Direction
UART	Universal Asynchronous Receiver-transmitter
USSD	Unstructured Supplementary Service Data
VSWR	Voltage Stationary Wave Ratio

Guangzhou Robustel LTD

Address: 3rd Floor, Building F, Kehui Park, No.95 Dagan Road,
Guangzhou, China 510660

Tel: 86-20-29019902

Email: info@robustel.com